

ZebraNet[®]

Wired and Wireless Print Servers

User Guide



© 2012 ZIH Corp. The copyrights in this manual and the software and/or firmware in the label printer described therein are owned by ZIH Corp. Unauthorized reproduction of this manual or the software and/or firmware in the label printer may result in imprisonment of up to one year and fines of up to \$10,000 (17 U.S.C.506). Copyright violators may be subject to civil liability.

This product may contain ZPL[®], ZPL II[®], and ZebraLink[™] programs; Element Energy Equalizer[®] Circuit; E³[®]; and Monotype Imaging fonts. Software © ZIH Corp. All rights reserved worldwide.

ZebraLink and all product names and numbers are trademarks, and Zebra, the Zebra logo, ZPL, ZPL II, Element Energy Equalizer Circuit, and E³ Circuit are registered trademarks of ZIH Corp. All rights reserved worldwide.

All other brand names, product names, or trademarks belong to their respective holders. For additional trademark information, please see “Trademarks” on the product CD.

Proprietary Statement This manual contains proprietary information of Zebra Technologies Corporation and its subsidiaries (“Zebra Technologies”). It is intended solely for the information and use of parties operating and maintaining the equipment described herein. Such proprietary information may not be used, reproduced, or disclosed to any other parties for any other purpose without the express, written permission of Zebra Technologies Corporation.

Product Improvements Continuous improvement of products is a policy of Zebra Technologies Corporation. All specifications and designs are subject to change without notice.

Liability Disclaimer Zebra Technologies Corporation takes steps to ensure that its published Engineering specifications and manuals are correct; however, errors do occur. Zebra Technologies Corporation reserves the right to correct any such errors and disclaims liability resulting therefrom.

Limitation of Liability In no event shall Zebra Technologies Corporation or anyone else involved in the creation, production, or delivery of the accompanying product (including hardware and software) be liable for any damages whatsoever (including, without limitation, consequential damages including loss of business profits, business interruption, or loss of business information) arising out of the use of, the results of use of, or inability to use such product, even if Zebra Technologies Corporation has been advised of the possibility of such damages. Some jurisdictions do not allow the exclusion or limitation of incidental or consequential damages, so the above limitation or exclusion may not apply to you.

Contents

About This Document	7
Who Should Use This Document	8
How This Document Is Organized	9
Contacts	10
Document Conventions	11
Related Documents	13
1 • Introduction	15
Overview	16
Support	16
Browser Support	16
Supported Services	16
Address Administration Protocols	16
Supported Wireless Radio Cards	17
Supported Security Types	18
Printer Requirements	22
Hardware — Wired Print Servers	22
Hardware — Wireless Print Servers	23
Memory Requirements	24
Firmware — 10/100 Print Server	25
Firmware — Wireless	27
Compatibility	28
Specifications	28
External ZebraNet 10/100 Print Server Specifications	28
Internal ZebraNet 10/100 Print Server Specifications	29
Wireless Print Server Specifications	30

2 • Installation	31
External ZebraNet 10/100 Print Server	32
Before You Begin	32
Illustration	33
Installation Instructions	34
Internal ZebraNet 10/100 Print Server	35
Wireless Print Servers	35
Install a Radio Card in a Wireless Print Server	35
Wireless Radio Card	35
Compact Flash Wireless Radio Card	37
3 • Getting Started	39
Before You Begin	41
Default User ID and Password	41
Printing a Configuration Label — External ZebraNet 10/100 Print Server	42
Printing a Network Configuration Label — Internal ZebraNet 10/100 Print Server and Wireless Print Servers	44
Configuration of Wireless Securities	49
View Wireless Status through the Control Panel	50
LCD Link Status and Wireless Signal Indicators	50
HC100 Wireless Status Indicator Lights	52
ZT210, ZT220, and ZT230 Wired and Wireless Status Indicator Lights	53
Determining the Active Print Server	55
Viewing IP Addresses and the Active Print Server	55
Active Device Selection	56
Assigning an IP Address on any Print Server	58
With Dynamic Host Configuration Protocol (DHCP)	58
Assigning an IP Address Without DHCP via ZebraNet Bridge	58
Assigning an IP address Without DHCP from the Control Panel	59
Assigning an IP Address Without DHCP via a Telnet Session	60
Setting and Monitoring Alerts on any Print Server	62
ZebraLink Alerts	62
Using ZebraNet Bridge	63
Using WebView	64
Checking Print Server Configuration Settings	66
Using ZebraNet Bridge	66
Using WebView	67
Enabling Protocols	70
Using WebView	70

- Defaulting ALL Print Servers 73
 - Using WebView 73
 - Using ZebraNet Bridge 74
 - Using a ZPL Command 74
 - Defaulting the ZebraNet 10/100 Print Server on the 105SL, S4M, PAX4
and External Devices 74
 - Defaulting the Wireless Print Server on the S4M 75
 - Defaulting the Print Servers on the ZM400 and ZM600 Printers 75
 - Defaulting the Print Servers on the ZP Series, LP/TLP 2824 Plus, and
G-Series Printers 75
 - Defaulting the Print Servers on the HC100 Printers 76
 - Defaulting the Print Servers on the 105SL, PAX4, Xi4, and ZE500 Printers 76
 - Defaulting the Print Servers on the ZT210 and ZT220 Printers 77
 - Defaulting the Print Servers on the ZT230 Printers 77
- 4 • Printing Queues 79**
 - Berkeley Software Distribution (BSD)-Style Print Queue 80
 - Configuring the Print Queue 80
 - System V Queue Installation 81
 - Configuring Operating System V Queue for ZebraNet Printing 81
 - Prerequisites 81
 - UNIX Configuration 81
- 5 • Using Printing Protocols 83**
 - IPP 84
 - FTP 85
- 6 • ZebraLink WebView 87**
 - WebView 88
 - Home Page 88
 - View Printer Configuration 90
 - View and Modify Printer Settings 91
 - Network Communications Screens 98
 - Directory Listing 103
 - Printer Controls 108
- 7 • Print Server Web Pages 109**
 - Print Server Features 110
 - Status and Configuration 110
 - Print Server Status 118
 - Reset 120
 - Restore 121

8 • Control Panel	123
Control Panel Menu Options	124
Wired Network Parameters on the LCD	124
Wireless Network Parameters on the LCD	126
9 • Hardware Troubleshooting	129
Troubleshooting the External 10/100 Print Server	130
Resetting to Factory Defaults	130
External ZebraNet 10/100 Print Server Network Status and Status Indicators	130
Troubleshooting the External ZebraNet 10/100 Print Server	131
Troubleshooting the Internal ZebraNet 10/100 Print Server	133
Resetting the Internal ZebraNet 10/100 Print Server to Factory Defaults	133
Internal ZebraNet 10/100 Print Server Network Status and Activity Indicators	133
Troubleshooting the Wireless Print Server	135
ZebraNet n Print Server Will Not Operate on the 5Ghz Band	135
Resetting the Wireless Print Server to Factory Defaults	135
ZebraNet Bridge Discovery or Configuration Problems	136
Unable to Print	136
Ping the Printer	136
Telnet	137
Unable to Configure Device	138
HP JetAdmin or HP Web JetAdmin	138
Wireless Error Messages	138
General Wireless Issues	139
Encryption and Authentication Issues	141
IP Issues	142
10 • Frequently Asked Questions	143
FAQs	143
Glossary	147
Index	153

About This Document

This section provides you with contact information, document structure and organization, and additional reference documents.

Contents

Who Should Use This Document	8
How This Document Is Organized	9
Contacts	10
Document Conventions	11
Related Documents	13

Who Should Use This Document

This User Guide is intended for anyone who will install and work with Zebra print servers (PS). The print servers addressed in this manual include:

- External ZebraNet 10/100 Print Server
- Internal ZebraNet 10/100 Print Server
- ZebraNet Wireless Print Server
- ZebraNet Wireless Plus Print Server
- ZebraNet Internal Wireless Plus Print Server
- ZebraNet b/g Print Server
- ZebraNet n Print Server

How This Document Is Organized

This User Guide is set up as follows:

Section	Description
<i>Introduction on page 15</i>	This chapter provides a high-level overview of Zebra's wired and wireless print servers, installation types, standard network configurations, and how to work with the print servers.
<i>Installation on page 31</i>	This chapter provides information on how to install the Zebra's wired and wireless print servers.
<i>Getting Started on page 39</i>	This section provides you with contact information, document structure and organization, and additional reference documents.
<i>Printing Queues on page 79</i>	This section provides information and instructions on configuring your printer for use with a BSD or System V Queue.
<i>Using Printing Protocols on page 83</i>	In this section, you are given steps to set up your print server to support Internet Printing Protocol (IPP) and File Transfer Protocol (FTP).
<i>ZebraLink WebView on page 87</i>	This section provides you with contact information, document structure and organization, and additional reference documents.
<i>Print Server Web Pages on page 109</i>	This section provides you with contact information, document structure and organization, and additional reference documents.
<i>Control Panel on page 123</i>	This section provides you with details on the Control Panel menu options.
<i>Hardware Troubleshooting on page 129</i>	This section provides you with solutions to known issues.
<i>Frequently Asked Questions on page 143</i>	This section provides a group of frequently asked questions (FAQs) about Zebra's wired and wireless print servers.
<i>Glossary on page 147</i>	This appendix is a list of terms and associated definitions.

Contacts

Technical Support via the Internet is available 24 hours per day, 365 days per year.

Web Site: www.zebra.com

Self Service Knowledge Base: www.zebra.com/knowledgebase

Online Case Registration: www.zebra.com/techrequest

Which Department Do You Need?	The Americas	Europe, Middle East, and Africa	Asia Pacific and India
Regional Headquarters	Zebra Technologies Corporation 475 Half Day Road, Suite 500 Lincolnshire, IL 60069 USA T: +1 847 634 6700 Toll-free +1 866 230 9494 F: +1 847 913 8766	Zebra Technologies Europe Limited Dukes Meadow Millboard Road Bourne End Buckinghamshire, SL8 5XF United Kingdom T: +44 (0) 1628 556000 F: +44 (0) 1628 556001	Zebra Technologies Asia Pacific Pte. Ltd. 120 Robinson Road #06-01 Parakou Building Singapore 068913 T: + 65 6858 0722 F: +65 6885 0838
Technical Support For questions on the operation of Zebra equipment and software, please call your distributor. For additional assistance, contact us. Please have your model and serial numbers available.	T: +1 877 ASK ZEBRA (275 9327) F: +1 847 913 2578 Hardware: ts1@zebra.com Software: ts3@zebra.com <i>Kiosk printers:</i> T: +1 866 322 5202 E: kiosksupport@zebra.com	T: +44 (0) 1628 556039 F: +44 (0) 1628 556003 E: Tseurope@zebra.com	T: +65 6858 0722 F: +65 6885 0838 E: China: tschina@zebra.com <i>All other areas:</i> tsasiapacific@zebra.com
Repair Service Department For back-to-base service and repair.	T: +1 877 ASK ZEBRA (275 9327) F: +1 847 821 1797 E: repair@zebra.com To request a repair in the U.S., go to www.zebra.com/repair .	T: +44 (0) 1772 693069 F: +44 (0) 1772 693046 New requests: ukrma@zebra.com Status updates: repairupdate@zebra.com	T: +65 6858 0722 F: +65 6885 0838 E: China: tschina@zebra.com <i>All other areas:</i> tsasiapacific@zebra.com
Technical Training Department For Zebra product training courses.	T: +1 847 793 6868 T: +1 847 793 6864 F: +1 847 913 2578 E: ttamerica@zebra.com	T: +44 (0) 1628 556000 F: +44 (0) 1628 556001 E: Eurtraining@zebra.com	T: + 65 6858 0722 F: +65 6885 0838 E: China: tschina@zebra.com <i>All other areas:</i> tsasiapacific@zebra.com
Inquiry Department For product literature and distributor and dealer information.	T: +1 877 ASK ZEBRA (275 9327) E: inquiry4@zebra.com	T: +44 (0) 1628 556037 F: +44 (0) 1628 556005 E: mseurope@zebra.com	E: China: GCmarketing@zebra.com <i>All other areas:</i> APACChannelmarketing@zebra.com
Customer Service Department (US) Internal Sales Department (UK) For printers, parts, media, and ribbon, please call your distributor or contact us.	T: +1 877 ASK ZEBRA (275 9327) E: clientcare@zebra.com	T: +44 (0) 1628 556032 F: +44 (0) 1628 556001 E: cseurope@zebra.com	T: +65 6858 0722 F: +65 6885 0836 E: China: order-csr@zebra.com <i>All other areas:</i> csasiapacific@zebra.com

Key: T: Telephone
F: Facsimile
E: E-mail

Document Conventions

The following conventions are used throughout this document to convey certain information:

Alternate Color (online only) Cross-references contain links to other sections in this guide. If you are viewing this guide online, click the [blue text](#) to jump to its location.

Command Line Examples All command line examples appear in `Courier New` font. For example, type the following to get to the Post-Install scripts in the `bin` directory:

```
Ztools
```

Files and Directories All file names and directories appear in `Courier New` font. For example, the `Zebra<version number>.tar` file and the `/root` directory.

Cautions, Important, Note, Example, and Print Server Icons



Caution • Advises you that failure to take or avoid a specific action could result in physical harm to you.

Caution • Advises you that failure to take or avoid a specific action could result in physical harm to the hardware.



Important • Advises you of information that is essential to complete a task.



Note • Indicates neutral or positive information that emphasizes or supplements important points of the main text.



Example • Provides an example, often a scenario, to better clarify a section of text.



This icon represents the external ZebraNet 10/100 Print Server.



This icon represents the internal ZebraNet 10/100 Print Server.



This icon represents the ZebraNet wireless print servers.

Illustration Instructions Used when an illustration contains either information about a dialog box or step(s) to accomplish in a dialog box.

One illustration instruction identifies a section of the dialog box and the other shows steps to follow.

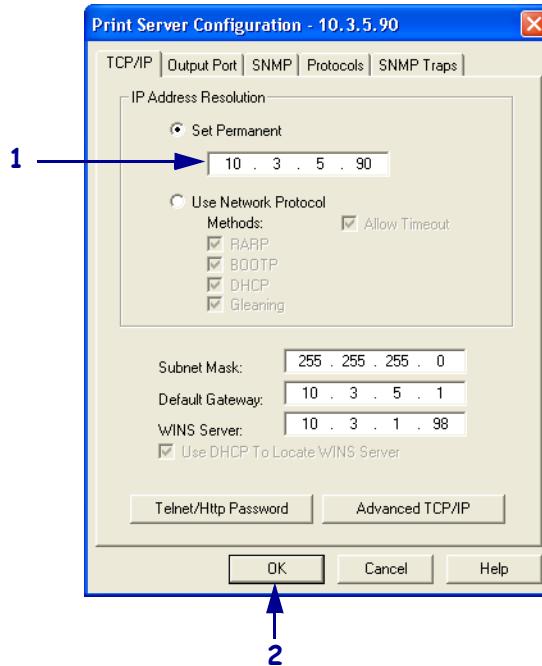

1	Set Permanent text-box.
2	a. In the Set Permanent text-box, type in the print server's IP address. b. When you are finished, click OK.

Related Documents

The following documents might be helpful references:

- *Programming Guide for ZPL II, ZBI 2, Set-Get-Do, Mirror, and WML*
- *ZebraNet Bridge Enterprise User Guide*
- ZebraNet Connectivity Solutions User and Reference Guides CD
- *EPL Programming Guide*



Notes •

Introduction

This chapter provides a high-level overview of Zebra’s wired and wireless print servers, installation types, standard network configurations, and how to work with the print servers.

Contents

Overview	16
Support	16
Browser Support	16
Supported Services	16
Address Administration Protocols	16
Supported Wireless Radio Cards	17
Supported Security Types	18
Printer Requirements	22
Hardware — Wired Print Servers	22
Hardware — Wireless Print Servers	23
Memory Requirements	24
Firmware — 10/100 Print Server	25
Firmware — Wireless	27
Compatibility	28
External ZebraNet 10/100 Print Server Specifications	28
External ZebraNet 10/100 Print Server Specifications	28
Internal ZebraNet 10/100 Print Server Specifications	29
Wireless Print Server Specifications	30

Overview

The print server is an optional factory- or field-installed device that connects the network and your ZebraLink-enabled printer. The print server provides you with a web browser as a user interface for printer and print server settings. If you use the ZebraNet Bridge, you can easily access the specialized features of a ZebraLink-enabled printer. For details, see the ZebraNet Bridge Enterprise User Guide.



Important • You can download the most recent version of ZebraNet Bridge Enterprise from www.zebra.com/utilities.

Support

This section lists the minimum requirements for print servers, which include browsers, supported services, address administration protocols, hardware, and firmware.

Browser Support

- HTML v3.2 or higher
- Internet Explorer

Supported Services

- Raw TCP
- HTTP
- LPR/LPD
- SNMPv1
- POP3
- IPP v1.0 * †
- FTP
- UDP
- Telnet
- SMTP
- WINS
- ARP

* Only supported on the external 10/100 Print Server.

† Only supported on the internal 10/100 Print Server for S4M, XiIIIPlus, PAX4, and 105SL.

Address Administration Protocols

- DHCP
- BootP
- RARP
- Gleaning
- Permanent



Supported Wireless Radio Cards



Note • This section applies only to the ZebraNet Wireless Print Server and the ZebraNet Wireless Plus Print Server. All other ZebraNet wireless print servers have a built-in radio.

A supported third-party PCMCIA, Compact Flash™, or CardBus wireless radio card is required for the printer to connect to the WLAN. After the wireless option board is installed in the printer, the wireless radio card inserts into a slot on this board. A wireless radio card is NOT provided with the ZebraNet Wireless Print Server or the ZebraNet Wireless Plus Print Server.



Note •

- Some wireless radio cards listed here may not support all ZebraNet wireless print server features.
- See [Table 1 on page 19](#) or check with the card manufacturer to ensure that the card that you wish to use supports the wireless security type used on your WLAN.
- Some wireless radio cards may require specific firmware versions to support certain features. You may be able to download new firmware to your wireless radio card. Check with the card manufacturer for more information.
- Check the operating conditions (such as temperature and humidity) for the wireless radio card that you choose. If the card has more restrictions than the printer, this may limit the conditions under which you can operate the printer with a wireless connection.

The following wireless radio cards are supported at the time of this release:

Symbol® Technologies

- Spectrum24® Compact Flash wireless radio card LA-4137-1020-WW (the card uses an adapter and must have firmware version F3.91-69 or later)
For instructions on how to install this card and the adapter, see [Install a Radio Card in a Wireless Print Server on page 35](#).
- 802.11b Spectrum24 High Rate Direct Sequence PN:LA-4121-1000-US (card must have firmware version V2.90-58 or later)
- 802.11b Spectrum24 High Rate Direct Sequence PN:LA-4121-1020-US (card must have firmware version V2.90-58 or later)
- 802.11b Spectrum24 High Rate Direct Sequence PN:LA-4121-1120-US (card must have firmware version V2.90-58 or later)

Cisco® Systems

All Aironet® cards must have card firmware version 5.60.21 or later.

- 802.11g Aironet CB21AG CardBus wireless radio card (for the Wireless Plus Print Server only)
- 802.11b Aironet AIR-PCMC340
- 802.11b Aironet AIR-PCMC341
- 802.11b Aironet AIR-PCMC342
- 802.11b Aironet PCMC350
- 802.11b Aironet PCMC351
- 802.11b Aironet PCMC352

Supported Security Types

Your WLAN can use any of a number of different types of security and encryption, or it can use none at all. This section shows which security types you can use with the various ZebraNet wireless print servers.



Note • Configuring a printer for WPA also allows the printer to be used in WPA2 environments.

ZebraNet Wireless Plus Print Server

Table 1 lists the security types that are supported by the Wireless Plus Print Server. Support varies by the card manufacturer and the card type. Select a wireless radio card that is supported by your wireless print server and that supports the security type being used on your WLAN.

Table 1 • Security Types Supported on the Wireless Plus Print Server

Security Type	Card Manufacturer			
	Cisco		Symbol	
	Cisco CB21	Cisco 350	LA-4121 (PCMCIA)	LA-4137 Compact Flash
Open	Yes	Yes	Yes	Yes
EAP-FAST	Yes	Not Supported	Yes	Yes
EAP-TLS	Yes	Not Supported	Not Supported	Yes
EAP-TTLS	Yes	Not Supported	Not Supported	Yes
Kerberos	Not Supported	Not Supported	Yes	Yes
LEAP	Yes	Yes	Yes	Yes
PEAP	Yes	Not Supported	Yes	Yes
WEP (40 bit and 128 bit)	Yes	Yes	Yes	Yes
WPA - LEAP	Yes	Yes	Yes	Yes
WPA - PSK	Yes	Yes	Yes	Yes
WPA- EAP-FAST	Yes	Yes	Yes	Yes
WPA- EAP-TLS	Yes	Yes	Yes	Yes
WPA- EAP-TTLS	Yes	Yes	Yes	Yes
WPA- PEAP	Yes	Yes	Yes	Yes
WPA2 - LEAP	Yes	Not Supported	Not Supported	Not Supported
WPA2 - PSK*	Yes*	Not Supported	Not Supported	Not Supported
WPA2- EAP-FAST	Yes	Not Supported	Not Supported	Not Supported
WPA2- EAP-TLS	Yes	Not Supported	Not Supported	Not Supported
WPA2- EAP-TTLS	Yes	Not Supported	Not Supported	Not Supported
WPA2- PEAP	Yes	Not Supported	Not Supported	Not Supported

* Key rotation for WPA2 PSK is supported in firmware version V60.15.8Z or later, V53.15.8Z or later., and RX.15.8Z or later.

ZebraNet Internal Wireless Plus Print Server, ZebraNet b/g Print Server, and ZebraNet n Print Server

Table 2 lists the security types that are supported by the Internal Wireless Plus Print Server, the b/g Print Server, and the n Print Server.

Table 2 • Security Types Supported on the Internal Wireless Plus Print Server, b/g Print Server and n Print Server

Security Type	Supported?
Open	Yes
EAP-FAST	Yes
EAP-PEAPv2	Yes *
EAP-TLS	Yes
EAP-TTLS	Yes
Kerberos	Not Supported
Key Management	Yes *
LEAP	Yes
MIC	Yes *
PEAP	Yes
WEP (40 bit and 128 bit)	Yes
WPA - LEAP	Yes
WPA - PSK	Yes
WPA - EAP-FAST	Yes
WPA - EAP-TLS	Yes
WPA - EAP-TTLS	Yes
WPA - PEAP	Yes
WPA - TKIP	Yes *
WPA2 - 802.1x + AES	Yes *
WPA2 - LEAP	Yes
WPA2 - PSK	Yes
WPA2 - EAP-FAST	Yes
WPA2 - EAP-TLS	Yes
WPA2 - EAP-TTLS	Yes
WPA2 - PEAP	Yes

*Note: Supported on the ZebraNet n Print Server only

ZebraNet Wireless Print Server

Table 3 lists the security types that are supported by the Wireless Print Server. Support varies by the card manufacturer and the card type. Select a wireless radio card that is supported by your wireless print server and that supports the security type being used on your WLAN. The Wireless Print Server does not support the Cisco CB21 radio card.

Table 3 • Security Types Supported on the Wireless Print Server

Security Type	Card Manufacturer		
	Cisco	Symbol	
	Cisco 350	LA-4121 (PCMCIA)	LA-4137 Compact Flash
Open	Yes	Yes	Yes
EAP-FAST	Not Supported	Not Supported	Yes
EAP-TLS	Not Supported	Not Supported	Yes
EAP-TTLS	Not Supported	Yes	Yes
Kerberos	Not Supported	Yes	Yes
LEAP	Yes	Yes	Yes
PEAP	Not Supported	Yes	Yes
WEP (40 bit and 128 bit)	Yes	Yes	Yes
WPA - LEAP	Yes	Yes	Yes
WPA - PSK	Yes	Yes	Yes
WPA- EAP-FAST	Yes	Yes	Yes
WPA- EAP-TLS	Yes	Yes	Yes
WPA- EAP-TTLS	Yes	Yes	Yes
WPA- PEAP	Yes	Yes	Yes

Printer Requirements



Hardware — Wired Print Servers



Table 4 indicates which printers are compatible with wired print server options.

Table 4 • Wired Print Servers Available by Printer

Printers	External *	Internal Field Upgrade	Internal Factory
105SL™	X	X	X
LP/TLP 2824 Plus™			X
GK420	X		X
GX420/430	X		X
HC100			X
PAX4™ series	X	X	X
R110PAX4™	X	X	X
R110Xi™	X	X	X
R170Xi™	X	X	X
R110Xi4™	X	X	X
RZ400™	X	X	X
RZ600™	X	X	X
S4M™	X	X *	X *
XiIIIPlus™	X	X	X
Xi4™	X	X	X
Z4Mplus™	X	X	X
Z6Mplus™	X	X	X
ZE500™	X	X	X
ZM400™	X	X	X
ZM600™	X	X	X
ZP Series			X
ZT210™	X	X	X
ZT220™	X	X	X
ZT230™	X	X	X

NOTES: * For additional information on print server firmware versions, see [Firmware — 10/100 Print Server on page 25](#).



Hardware — Wireless Print Servers

Table 5 indicates which printers are compatible with wireless print server options.

Table 5 • Wireless Print Servers Available by Printer

Printers	ZebraNet n Print Server	ZebraNet b/g Print Server	Internal Wireless Plus Print Server	Wireless Plus Print Server	Wireless Print Server
105SL™			X	X	X
LP/TLP 2824 Plus					
GK420					
GX420/430					
HC100					
PAX4™ series		X	X	X	X
R110PAX4™			X	X	X
R110Xi™			X	X	X
R170Xi™			X	X	X
R110Xi4™		X	X	X	X
RZ400™		X	X	X	X
RZ600™		X	X	X	X
S4M™		X	X	X	X
XiIIIPlus™			X	X	X
Xi4™		X	X	X	
Z4Mplus™					X
Z6Mplus™					X
ZE500™		X			
ZM400™		X	X	X	
ZM600™		X	X	X	
ZP Series					
ZT210™	X				
ZT220™	X				
ZT230™	X				
R4Mplus					X
R110Xi HF			X	X	X

Memory Requirements

PCMCIA and Compact Flash Memory Cards PCMCIA memory or Compact Flash memory cards will not work and are not supported on the Wireless Plus Print Server. The Internal Wireless Plus Print Server and the b/g Print Server do not include a slot for these card types.

Wireless Card Socket Option The ZebraNet wireless print server options replace the Wireless Card Socket Option (WCSO) in 105SL printers with a serial number of 6400357 or greater. Do not install a wireless option board on a 105SL printer with a serial number that is less than 6400357.

Wireless Option Board A special wireless option board must be installed in your printer/print engine. To determine if you have a wireless option board installed, use a printer configuration label (refer to the instructions in the User Guide that came with your printer). To purchase a wireless option, contact your authorized Zebra reseller for more information.

The wireless option boards are identified by the `HARDWARE ID` line on the printer configuration label.

```

+10..... LCD ADJUST
DPSWF*.. MODES ENABLED
..... MODES DISABLED
832 8/MM FULL..... RESOLUTION
V50 15 17<-..... FIRMWARE
V23 29882-001_3.... HARDWARE ID
CUSTOMIZED..... CONFIGURATION
3264k.....R: RAM
61440k.....E: ONBOARD FLASH
NONE..... FORMAT CONVERT
FW VERSION..... IDLE DISPLAY
    
```

The part numbers shown on the `HARDWARE ID` line indicate the wireless print servers as shown in [Table 6](#).

Table 6 • Zebra Part Numbers for ZebraNet Wireless Print Server Boards

Part Number	Corresponds to the Following
P1033782-0x	n Print Server
P1033557-0xx	b/g Print Server
P1033605-001	
29652-0xx	Internal Wireless Plus Print Server
29883-001	
29651-0xx	Wireless Plus Print Server
29882-001	
29881-009	Wireless Print Server
79077	
79078	
79079	
79100	



Firmware — 10/100 Print Server

The S4M printers and all external print servers are available with several versions of print server firmware. *PAX4*, *105SL*, *XiIIIPlus* printers will use print server firmware version 1.01.x.

To determine the proper firmware version, first determine your hardware version.

To locate your hardware version, perform the following:

1. Which type of printer and print server do you have?

If you have...	Then...
Any printer with an external print server	<ol style="list-style-type: none"> Look at the side of the print server. See Figure 1 on page 26. Your version is listed on the Compliance label. Your hardware version number is either blank or V2. <ul style="list-style-type: none"> If your hardware version is blank, assume this means V1 (version 1). You will need firmware version 1.01.x. If your hardware version is V2, you will need firmware version 2.01.x.
An S4M printer with an internal print server	<ol style="list-style-type: none"> Look at the back plate of the printer. See Figure 2 on page 26. Your version is listed on the thin Compliance label on the bracket of the wired print server. The version number is shown as blank or V2. <ul style="list-style-type: none"> If your hardware version is blank, assume this means V1 (version 1). You will need firmware version 1.01.x. If your hardware version is V2, you will need firmware version 2.01.x.
All other printers with an internal print server	<ol style="list-style-type: none"> Your hardware version will be V1. You will need firmware version 1.01.x.

Figure 1 • External 10/100 Print Server Sample Compliance Label

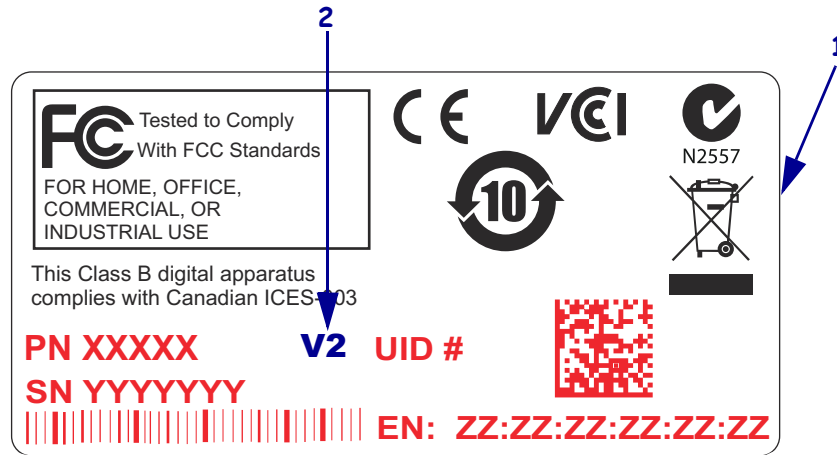

1	Sample Compliance label
2	Location of hardware version

Figure 2 • Internal 10/100 Print Server Sample Compliance Label



1	Sample Compliance label (vertically oriented on the back of the printer)
2	Location of hardware version



Firmware — Wireless

After a wireless option board is installed, your printer must be running a supported firmware version to access the features in this manual. [Table 7](#) shows the minimum firmware version required.

You may download the latest firmware appropriate for your printer to access the latest encryption features. Go to <http://www.zebra.com/firmware> for firmware download options.

Table 7 • Supported Firmware Versions

Printer	ZebraNet n Print Server	ZebraNet b/g Print Server	ZebraNet Internal Wireless Plus Print Server	ZebraNet Wireless Plus Print Server	ZebraNet Wireless Print Server
105SL	—	—	V60.16.X	V60.15.X	V60.15.X
HC100	—	—	V54.16.X	—	—
110PAX4, 170PAX4	—	V60.17.11Z	V60.16.X	V60.15.X	V60.15.X
R110PAX4	—	—	R62.16.X R63.16.X	R62.15.X R63.15.X	R62.15.X R63.15.X
R110Xi, R170Xi	—	—	R60.16.X	R60.15.X	R60.15.X
R110Xi HF	—	—	R65.16.X	R65.15.X	R65.15.X
R110Xi4	—	V53.17.11Z	V.53.17.7	V.53.17.7	—
R4Mplus	—	—	—	—	ZSP994P ZSP999F ZSP1027 ZSP1056E ZSP1082F
RZ400, RZ600	—	V53.17.11Z	R53.16.X	R53.16.X	R53.16.X
S4M	—	V53.17.11Z	V53.16.X	V50.15.X V53.15.X	V50.15.X V53.15.X
Xi///Plus	—	—	V60.16.X	V60.15.X	V60.15.X
Xi4	—	V53.17.11Z	V53.17.X	V53.17.X	—
Z4Mplus, Z6Mplus	—	—	—	—	V60.15.X
ZM400, ZM600	—	V53.17.11Z	V53.16.X	V53.15.X	—
ZE500	—	V53.17.X	—	—	—
ZT210	V72.18.X	—	—	—	—
ZT220	V72.18.X	—	—	—	—
ZT230	V72.18.X	—	—	—	—

Compatibility

This section identifies the various components that are compatible with all print servers.

Software IBM®: Tivoli® v7.1.3, HP®: Web JetAdmin™ v7.0, OpenView™ v6.4, and any SNMP management application via Zebra Management Information Base (MIB) all work with both the wired and wireless print servers.

Specifications



External ZebraNet 10/100 Print Server Specifications

General Specifications			
Network Connection		Ethernet 10BASE-T and 100BASE-T UTP RJ-45 connection Half and Full Duplex Communications	
Printer Connection		Bi-directional, IEEE-1284 Centronics parallel port (Compatibility, Nibble, and ECP)	
User Interface		LED activity indicators: <ul style="list-style-type: none"> • bi-color display of operational status • bi-color display of speed and network activity 	
Height (external dimensions)		1.2 in.	30.48 mm
Width (external dimensions)		2.8 in.	71.12 mm
Length (external dimensions)		3.2 in.	81.28 mm
Weight		2.7 oz	77 g
Electrical		Maximum 450mA at 5.25VDC Power provided by the printer (Centronics pin 18, 5VDC at 450mA)	
Temperature	Operating	32° to 104°F	0° to 40°C
	Storage	-40° to 140°F	-40° to 60°C
Relative Humidity	Operating	20% to 85%, non-condensing	
	Storage	5% to 85%, non-condensing	
Agency Approvals		Agency Approvals <ul style="list-style-type: none"> • IEC 60950 • EN 55022, class B • EN 55024 • AS/NZS3548 Agency Marks <ul style="list-style-type: none"> • FCC - B • ICES-003 • VCCI • C-Tick 	



Internal ZebraNet 10/100 Print Server Specifications

General Specifications			
Network Connection		Ethernet 10BaseT and 100BaseT UTP RJ-45 connection Half and Full Duplex Communications	
User Interface		A single (two element) LED activity indicator: <ul style="list-style-type: none"> • bi-color display of operational status (solid green or solid amber) • bi-color display of speed and network activity (flashing green or flashing amber) 	
Height (external dimensions)		0.5 in.	13.4 mm
Width (external dimensions)		2.2 in.	55.9 mm
Length (external dimensions)		3.7 in.	92.9 mm
Weight		0.9 oz	26 g
Temperature	Operating	32° to 140°F	0° to 60°C
	Storage	-40° to 140°F	-40° to 60°C
Relative Humidity	Operating	20% to 80%, non-condensing	
	Storage	5% to 85%, non-condensing	



Wireless Print Server Specifications

General Specifications

Network Connection		All Wireless Print Servers	<ul style="list-style-type: none"> • IEEE 802.11b/g • Data Rates up to 54 Mb per second • Wireless Medium DSSS and OFDM • Frequency Band: 2.4 GHz 	
		n Print Server	<ul style="list-style-type: none"> • IEEE 802.11a/b/g/n • Data Rates up to 150 Mbps • Wireless Medium DSSS and OFDM • Frequency Band: 2.4 and 5 GHz 	
User Interface		<ul style="list-style-type: none"> • Link Status Indicator—real-time display of network status • Wireless Signal Indicators 		
Electrical		Power provided by the printer		
Temperature	Operating	32° to 140°F	0° to 60°C	
	Storage	-40° to 140°F	-40° to 60°C	
Relative Humidity	Operating	20% to 80%, non-condensing		
	Storage	5% to 85%, non-condensing		

2

Installation

This chapter provides information on how to install the Zebra's wired and wireless print servers.

Contents

External ZebraNet 10/100 Print Server	32
Before You Begin	32
Illustration	33
Installation Instructions	34
Internal ZebraNet 10/100 Print Server	35
Wireless Print Servers	35
Install a Radio Card in a Wireless Print Server	35
Wireless Radio Card	35
Compact Flash Wireless Radio Card	37



External ZebraNet 10/100 Print Server

This section provides you with an illustration of the external ZebraNet 10/100 Print Server and the steps required for its installation. For a list of compatible printers, see *Hardware — Wired Print Servers* on page 22.

Before You Begin



Important • In order to take advantage of all features described in this manual, you must download firmware X.14 or later.



Note • Not all printers support firmware X.14 or later. On those printers, the features for this print server will be limited.

To upgrade your printer firmware, complete these steps:

1. If your printer has firmware x.12 firmware, you **must** upgrade your printer firmware to version x.14.x or higher.
2. To upgrade your firmware, visit the Zebra Web site:
www.zebra.com/firmware
3. Confirm that the upgrade was successful:

If...	Then...
Your printer has an LCD	Look at the lower right-hand corner and confirm the version of firmware that is on your printer.
Your printer does not have an LCD	Print out a configuration label to see the version of firmware that is on your printer.

Illustration

Figure 3 shows an external ZebraNet 10/100 Print Server. When necessary, refer back to this illustration during the installation steps.

Figure 3 • External ZebraNet 10/100 Print Server

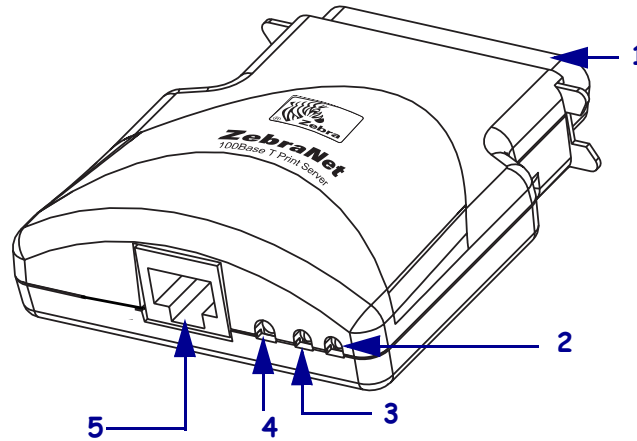

1	Parallel connector
2	Network status LED
3	Status LED
4	Test button
5	Ethernet connector

For more details on status indicators, see [External ZebraNet 10/100 Print Server Network Status and Status Indicators](#) on page 130.

Installation Instructions

To install an external ZebraNet 10/100 Print Server, complete these steps:

1. Turn off (O) the printer.
2. On the back of the printer, connect the external ZebraNet 10/100 Print Server device to the parallel port.

Figure 4 shows the location and provides an enlarged illustration of the parallel port.

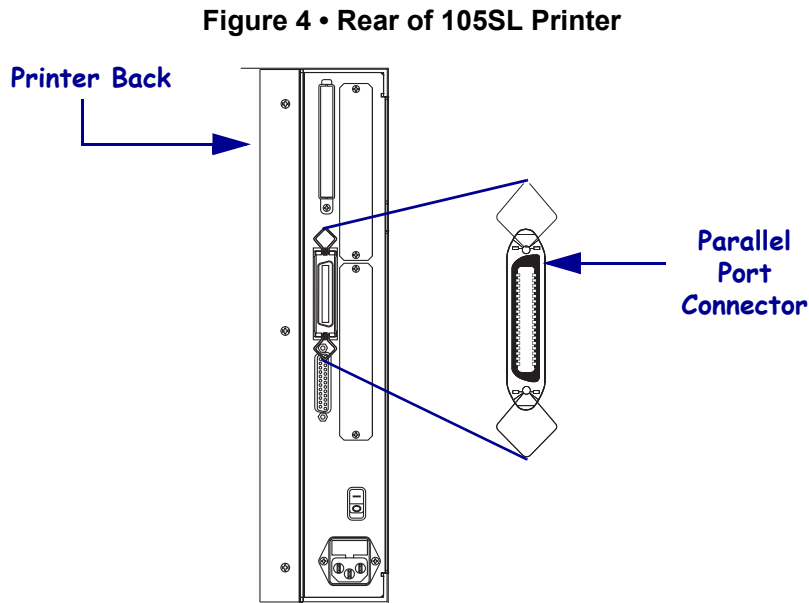

3. Secure the wire locks.
4. On the back of the external ZebraNet 10/100 Print Server, connect an active Ethernet cable to the RJ-45 connector Ethernet connector.
5. Turn on (I) the printer.

The external ZebraNet 10/100 Print Server performs a Power On Self-Test (POST). This takes about 45 seconds. During the POST, the external ZebraNet 10/100 Print Server Status LED (just below the TEST button) turns red and flashes on and off. Once the POST is successfully completed and the external ZebraNet 10/100 Print Server is fully initialized, the Status LED turns green.

For more details on status indicators, see [External ZebraNet 10/100 Print Server Network Status and Status Indicators](#) on page 130.



Note • If there is not an active Ethernet cable attached to the external ZebraNet 10/100 Print Server, the Status LED turns red and slowly flashes on and off.

6. To check the status of the external ZebraNet 10/100 Print Server, press the Test button located on the back of the external ZebraNet 10/100 Print Server.

This prints out a configuration label of the external ZebraNet 10/100 Print Server. To see a sample label, see [Figure 6](#) on page 43.



Internal ZebraNet 10/100 Print Server

To install an internal ZebraNet 10/100 Print Server, see the installation instructions on the Connectivity Solutions CD.



Wireless Print Servers

To install a wireless print server, see the installation instructions on the Connectivity Solutions CD.



Install a Radio Card in a Wireless Print Server



Note • This section applies only to the ZebraNet Wireless Print Server and the ZebraNet Wireless Plus Print Server. All other ZebraNet wireless print servers have a built-in radio.

Printers that have the wireless option board installed can use any of the wireless radio cards or Compact Flash wireless radio cards listed in [Supported Wireless Radio Cards on page 17](#). This section provides instructions for installing either type of card. Most printers use a clear plastic RF cover over the wireless radio card or compact Flash wireless radio card.

Wireless Radio Card

This section applies to PCMCIA or CardBus wireless radio cards.



Note • Z4Mplus, R4Mplus, and Z6Mplus printers do not support CardBus wireless radio cards.

To install a wireless radio card, complete these steps:

1. Turn off (O) the printer.
2. Remove and discard the metal cover that was shipped in place over the wireless option card slot on the back of the printer.

36 | Installation

Install a Radio Card in a Wireless Print Server

3. Position the notch on the wireless radio card on the top, leading edge. Insert the wireless radio card into the wireless option card slot on the back of the printer until the card-eject button pops out.

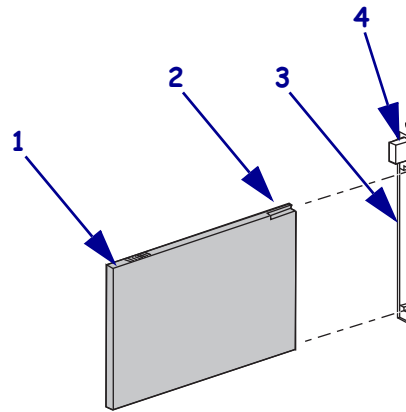

1	Wireless radio card
2	Notch
3	Wireless option card slot on back of printer
4	Card-eject button

4. Place the RF card cover over the wireless radio card, and secure it with a small screw.



Note • The S4M, ZM400, ZM600, RZ400, and RZ600 printers do not use the RF card cover.

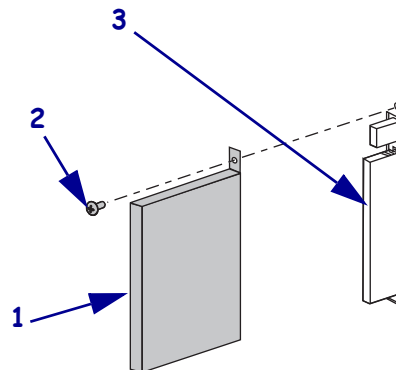

1	Clear plastic RF card cover (not used on all printers)
2	Screw
3	Wireless radio card

5. Turn on (I) the printer.

The printer restarts and uses the wireless radio card to communicate with your WLAN. Allow several minutes for the printer to connect to the network. For more information about wireless status, refer to [View Wireless Status through the Control Panel on page 50](#) or [Troubleshooting the Wireless Print Server on page 135](#).

Compact Flash Wireless Radio Card

This section applies to Compact Flash wireless radio cards, which require an adapter before they can be used in the wireless option card slot.

To install a Compact Flash wireless radio card and adapter, complete these steps:

1. If you have not already done so, turn off (O) the printer.
2. Remove and discard the metal cover that was shipped in place over the wireless option slot on the back of the printer.
3. See [Figure 5](#). Position the adapter with the back facing as shown. Insert the adapter into the wireless option card slot on the back of the printer until the card-eject button pops out.
4. See [Figure 5](#). Insert the Compact Flash wireless radio card into the adapter.

Figure 5 • Installing a Compact Flash Wireless Radio Card

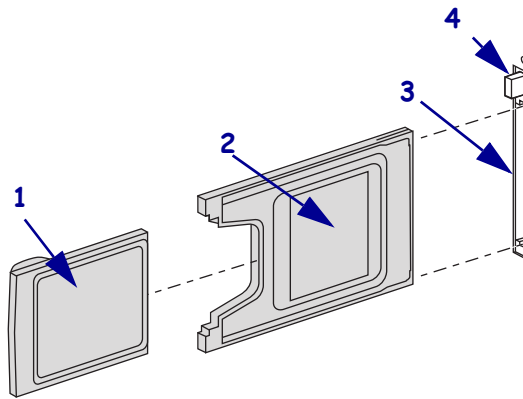

1	Back of Compact Flash wireless radio card
2	Back of adapter
3	Wireless option card slot on back of printer
4	Card-eject button

38 | Installation

Install a Radio Card in a Wireless Print Server

5. Place the RF card cover over the wireless radio card, and secure it with a small screw.



Note • The S4M, ZM400, ZM600, RZ400, and RZ600 printers do not use the RF card cover.

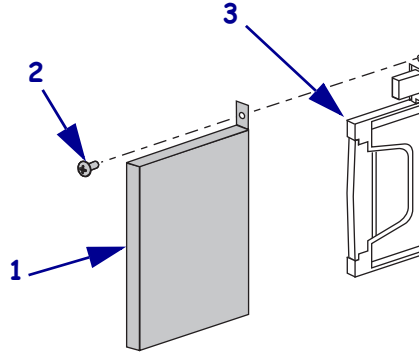

1	Clear plastic RF card cover (not used on all printers)
2	Screw
3	Compact Flash wireless radio card and adapter

6. Turn on **(I)** the printer.

The printer restarts and uses the wireless radio card to communicate with your WLAN. Allow several minutes for the printer to connect to the network. For more information about wireless status, refer to [View Wireless Status through the Control Panel on page 50](#) or [Troubleshooting the Wireless Print Server on page 135](#).

Getting Started

This chapter provides you with information and procedures for working with the most frequently used print server features.

Contents

Before You Begin	41
Default User ID and Password	41
Printing a Configuration Label — External ZebraNet 10/100 Print Server	42
Printing a Network Configuration Label — Internal ZebraNet 10/100 Print Server and Wireless Print Servers	44
Configuration of Wireless Securities	49
View Wireless Status through the Control Panel	50
LCD Link Status and Wireless Signal Indicators	50
HC100 Wireless Status Indicator Lights	52
ZT210, ZT220, and ZT230 Wired and Wireless Status Indicator Lights	53
Determining the Active Print Server	55
Viewing IP Addresses and the Active Print Server	55
Active Device Selection	56
Assigning an IP Address on any Print Server	58
With Dynamic Host Configuration Protocol (DHCP)	58
Assigning an IP Address Without DHCP via ZebraNet Bridge	58
Assigning an IP address Without DHCP from the Control Panel	59
Assigning an IP Address Without DHCP via a Telnet Session	60
Setting and Monitoring Alerts on any Print Server	62
ZebraLink Alerts	62
Using ZebraNet Bridge	63
Using WebView	64

Contents (Continued)

Checking Print Server Configuration Settings 66
 Using ZebraNet Bridge 66
 Using WebView 67
 Enabling Protocols 70
 Using WebView 70
 Defaulting ALL Print Servers 73
 Using WebView 73
 Using ZebraNet Bridge 74
 Defaulting the ZebraNet 10/100 Print Server on the 105SL, S4M, PAX4 and External
 Devices 74
 Defaulting the Wireless Print Server on the S4M. 75
 Defaulting the Print Servers on the ZM400 and ZM600 Printers 75
 Defaulting the Print Servers on the ZP Series, LP/TLP 2824 Plus, and G-Series Printers
 75
 Defaulting the Print Servers on the HC100 Printers 76
 Defaulting the Print Servers on the 105SL, PAX4, Xi4, and ZE500 Printers 76
 Defaulting the Print Servers on the ZT210 and ZT220 Printers. 77
 Defaulting the Print Servers on the ZT230 Printers 77

Before You Begin

Zebra's wired and wireless print servers offers many features, but how you access and work with them is dependent on your environment.

Default User ID and Password

Throughout the procedures in this document, there are some features that require the default User ID and/or default password. If you are prompted, these are the defaults:

- **User ID:** admin
- **Password:** 1234



Printing a Configuration Label — External ZebraNet 10/100 Print Server

Before you begin, you need to get information from the external ZebraNet 10/100 Print Server configuration label.



Important • Make sure the printer is turned off (O).

In order to print the external ZebraNet 10/100 Print Server configuration label, the correct media size must be loaded in the printer. For specific information on media sizes, see [Table 8](#).

Table 8 • Label Width

DPI	Inches	mm
600	1.63	41.28
300	1.63	41.28
211	2.5	63.5
150	5.0	127.00

To print an external ZebraNet 10/100 Print Server configuration label, complete these steps:

1. Turn on (I) the printer and let it complete its power-up cycle.
2. When the POST cycle is complete, press the Test button and hold it in for a few seconds before you release it.

An external ZebraNet 10/100 Print Server configuration label prints. Your configuration label looks similar to [Figure 6 on page 43](#).

Figure 6 • Configuration Label with an External ZebraNet 10/100 Print Server

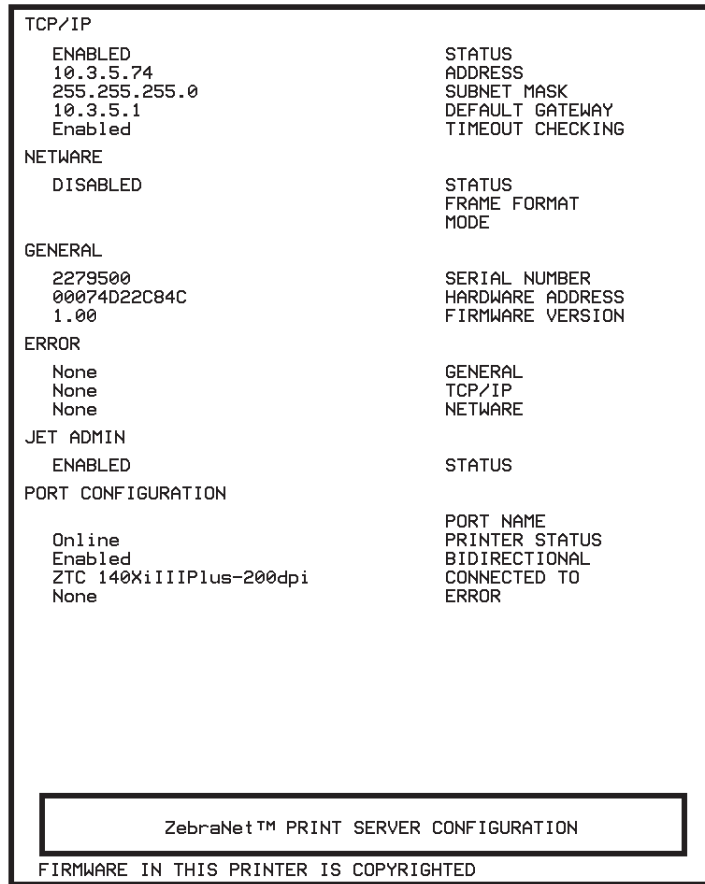

3. From the configuration label, you need to look for these numbers:
 - ADDRESS (IP address)
 - SUBNET MASK
 - DEFAULT GATEWAY
 - SERIAL NUMBER
 - HARDWARE ADDRESS (MAC address)

4. On the configuration label that prints out for your external ZebraNet 10/100 Print Server device, circle the aforementioned settings. You can now proceed to [Assigning an IP Address on any Print Server on page 58](#).



Printing a Network Configuration Label — Internal ZebraNet 10/100 Print Server and Wireless Print Servers

Before you begin, you need to get information from the internal ZebraNet 10/100 Print Server network configuration label.

Table 9 shows the minimum label widths needed to print an internal ZebraNet 10/100 Print Server network configuration label with different DPI printheads.

Table 9 • Label Width

DPI	Inches	MM
600	1.25	31.75
300	2.50	63.50
200	3.69	93.73

To print an internal ZebraNet 10/100 Print Server and wireless print servers network configuration label, complete these steps:

1. Which printer do you have?

If you have a...	Then...
ZM400 and ZM600	<ol style="list-style-type: none"> Turn on (I) the printer and let it complete its power-up cycle. When the POST cycle is complete, press Setup/Exit to enter the Setup Mode. Scroll through the parameters by pressing Plus (+) until you reach List Network. Press Select. Press Plus (+) to print a network configuration label (Figure 7). Press Setup/Exit twice to exit the Setup Mode. Continue to step 2.
G-Series, ZP Series, and LP/TLP 2824 Plus	<ol style="list-style-type: none"> Turn on (I) the printer and let it complete its power-up cycle. Press and hold Feed until you see one flash of the LED. After the LED flashes, release the button. A network and printer configuration label (Figure 9) prints. Continue to step 2.

If you have a...	Then...
HC100	 <p>Note • The HC100 does not have a network configuration label. However, the IP Address, MAC Address, and other useful information appear on the printer configuration wristband.</p> <ol style="list-style-type: none"> Turn on (I) the printer and let it complete its power-up cycle. Press and hold Pause/Feed until the green lights turn off on the printer status indicator and the orange lights blink once. Release Pause/Feed to print a printer configuration wristband (Figure 10). Continue to step 2.
ZT210, ZT220, and ZT230	<p>Refer to the User Guide for your printer for specific instructions on how to use the control panel. (See Figure 9 for a sample ZT210, ZT220, and ZT230 printer configuration label.)</p>
Xi4, PAX4, 105SL, ZE500	<ol style="list-style-type: none"> Turn on (I) the printer and let it complete its power-up cycle. When the POST cycle is complete, press Setup/Exit to enter the Setup Mode. Scroll through the parameters by pressing Next/Save (▶) until you reach List Network. Press Plus (+) to print a network configuration label (Figure 7). Press Setup/Exit to exit the Setup Mode. Press Next/Save to permanently save your changes.
S4M	<ol style="list-style-type: none"> From the control panel, enter Setup Mode. (Refer to the User Guide for your printer for specific instructions on how to use the control panel.) Scroll to level 3 parameter PRINT OUT NETWORK (for a network configuration label) or PRINT OUT SETTINGS (for a standard configuration label). Press ENTER to confirm printing. The selected label prints. Press Menu to exit the Setup Mode. If necessary, press the up or down arrow to select Yes. Press Enter to save changes and exit Setup mode.

2. From the configuration label, you need to look for these numbers:
 - IP PROTOCOL *
 - IP ADDRESS
 - SUBNET MASK *
 - DEFAULT GATEWAY *
 - MAC ADDRESS
- * Not available on HC100
3. On the configuration label that prints out for your internal ZebraNet 10/100 Print Server, circle the aforementioned settings. You can now proceed to [Assigning an IP Address on any Print Server on page 58](#).

Figure 7 • Network Configuration Label for ZM400/ZM600, Xi4, PAX4, 105SL, ZE500

Zebra Technologies ZTC ZM400-200dpi ZPL ZBR2834777	
1.36.1733	OPTION FIRMWARE
Wired	PRIMARY NETWORK
NO	LOAD FROM EXT?
Internal Wired	ACTIVE PRINTSRVR
External Wired	
ALL	IP PROTOCOL
000.000.000.000	IP ADDRESS
255.255.255.000	SUBNET MASK
000.000.000.000	DEFAULT GATEWAY
000.000.000.000	WINS SERVER IP
YES	TIMEOUT CHECKING
300	TIMEOUT VALUE
000	ARP INTERVAL
9100	BASE RAW PORT
Internal Wired*	
ALL	IP PROTOCOL
010.003.005.090	IP ADDRESS
255.255.255.000	SUBNET MASK
010.003.005.001	DEFAULT GATEWAY
010.003.001.098	WINS SERVER IP
YES	TIMEOUT CHECKING
300	TIMEOUT VALUE
000	ARP INTERVAL
9100	BASE RAW PORT
00074d2b4159	MAC ADDRESS
Wireless	
ALL	IP PROTOCOL
000.000.000.000	IP ADDRESS
255.255.255.000	SUBNET MASK
000.000.000.000	DEFAULT GATEWAY
010.003.001.098	WINS SERVER IP
YES	TIMEOUT CHECKING
300	TIMEOUT VALUE
000	ARP INTERVAL
9100	BASE RAW PORT
NO	CARD INSERTED
0000H	CARD MFG ID
0000H	CARD PRODUCT ID
000000000000	MAC ADDRESS
YES	DRIVER INSTALLED
INFRASTRUCTURE	OPERATING MODE
vh-CTC-PRD	ESSID
100	TX POWER
ON	1 Mb/s
ON	2 Mb/s
ON	5.5 Mb/s
ON	11 Mb/s
11 Mb/s	CURRENT TX RATE
DIVERSITY	RECEIVE ANTENNA
DIVERSITY	XMIT ANTENNA
OPEN	WEP TYPE
WEP 128-BIT	WLAN SECURITY
1	WEP INDEX
020	POOR SIGNAL
LONG	PREAMBLE
NO	ASSOCIATED
ON	PULSE ENABLED
15	PULSE RATE
OFF	INTL MODE
07FFH	CHANNEL MASK

FIRMWARE IN THIS PRINTER IS COPYRIGHTED

Figure 8 • Network Configuration Label for ZT210, ZT220, and ZT230

Network Configuration	
Zebra Technologies ZTC ZT230-300dpi ZPL XXXXXX-XX-XXXX	
PrintServer.....	LOAD LAN FROM?
UNKNOWN.....	ACTIVE PRINTSRVR
Wired	
ALL.....	IP PROTOCOL
000.000.000.000....	IP ADDRESS
255.255.255.000....	SUBNET
000.000.000.000....	GATEWAY
000.000.000.000....	WINS SERVER IP
YES.....	TIMEOUT CHECKING
300.....	TIMEOUT VALUE
000.....	ARP INTERVAL
9100.....	BASE RAW PORT
Wireless	
ALL.....	IP PROTOCOL
000.000.000.000....	IP ADDRESS
255.255.255.000....	SUBNET
000.000.000.000....	GATEWAY
000.000.000.000....	WINS SERVER IP
YES.....	TIMEOUT CHECKING
300.....	TIMEOUT VALUE
000.....	ARP INTERVAL
9100.....	BASE RAW PORT
NOT INSERTED.....	CARD INSERTED
H.....	CARD MFG ID
H.....	CARD PRODUCT ID
00:00:00:00:00:00..	MAC ADDRESS
YES.....	DRIVER INSTALLED
INFRASTRUCTURE.....	OPERATING MODE
125.....	ESSID
100.....	TX POWER
ALL.....	CURRENT TX RATE
OPEN.....	WEP TYPE
NONE.....	WLAN SECURITY
1.....	WEP INDEX
000.....	PODR SIGNAL
LONG.....	PREAMBLE
NO.....	ASSOCIATED
ON.....	PULSE ENABLED
15.....	PULSE RATE
OFF.....	INTL MODE
0x3FFFFFFFFF.....	CHANNEL MASK
FIRMWARE IN THIS PRINTER IS COPYRIGHTED	

Figure 9 • Network Configuration Label for G-Series, ZP Series, and LP/TLP 2824 Plus Printers

Network Configuration	
Zebra Technologies ZTC GX420d ZBR2941050	
Internal Wired*	
ALL.....	IP PROTOCOL
010.003.004.088....	IP ADDRESS
255.255.255.000....	SUBNET MASK
010.003.004.001....	DEFLT. GATEWAY
010.003.001.098....	WINS SERVER IP
YES.....	TIMEOUT CHECKING
300.....	TIMEOUT VALUE
000.....	ARP INTERVAL
9100.....	BASE RAW PORT
00:07:4d:2c:e0:7a..	MAC ADDRESS
FIRMWARE IN THIS PRINTER IS COPYRIGHTED	

Figure 10 • Printer Configuration Wristband for HC100

PRINTER CONFIGURATION	
+000.....	TEAR OFF
CONNECTED.....	USB COMM.
9600,8,N,2,X,N,w,^,,	SERIAL COMM.
ZV54.16.0Z<-.....	FIRMWARE
000.000.000.000.....	IP ADDRESS
000000000000	MAC ADDRESS
FIRMWARE IN THIS PRINTER IS COPYRIGHTED	

The IP ADDRESS and MAC ADDRESS fields will have values only if a wired or wireless print server is active.

Figure 11 • Printer Configuration Label for ZT210, ZT220, and ZT230

PRINTER CONFIGURATION	
Zebra Technologies	
ZTC ZT230-300dpi ZPL	
XXXXXX-XX-XXXX	
+30.....	DARKNESS
4.0 IPS.....	PRINT SPEED
+000.....	TEAR OFF
TEAR OFF.....	PRINT MODE
GAP/NOTCH.....	MEDIA TYPE
REFLECTIVE.....	SENSOR SELECT
THERMAL-TRANS.....	PRINT METHOD
1248.....	PRINT WIDTH
1617.....	LABEL LENGTH
No Serial Number Available	HEAD ID
38.0IN 888MM.....	MAXIMUM LENGTH
NOT CONNECTED.....	USB COMM.
BIDIRECTIONAL.....	PARALLEL COMM.
RS232.....	SERIAL COMM.
9600.....	BAUD
8 BITS.....	DATA BITS
NONE.....	PARITY
XON/XOFF.....	HOST HANDSHAKE
NONE.....	PROTOCOL
NORMAL MODE.....	COMMUNICATIONS
<w> 7EH.....	CONTROL PREFIX
<^> 5EH.....	FORMAT PREFIX
<, > 2CH.....	DELIMITER CHAR
ZPL II.....	ZPL MODE
CALIBRATION.....	MEDIA POWER UP
CALIBRATION.....	HEAD CLOSE
DEFAULT.....	BACKFEED
+000.....	LABEL TOP
+0000.....	LEFT POSITION
DISABLED.....	REPRINT MODE
020.....	WEB S.
050.....	MEDIA S.
040.....	RIBBON S.
255.....	TAKE LABEL
085.....	MARK S.
128.....	TRANS GAIN
000.....	TRANS BAGE
141.....	TRANS BRIGHT
128.....	RIBBON GAIN
002.....	MARK GAIN
DPCSWFXM.....	MODES ENABLED
.....	MODES DISABLED
1248 12/PM FULL.....	RESOLUTION
V72.18.12P14006 <-.....	FIRMWARE
1.3.....	XML SCHEMA
8.4.1 0.....	HARDWARE ID
NONE.....	OPTION BOARD
4096k.....	R: RAM
65536k.....	E: ONBOARD FLASH
NONE.....	FORMAT CONVERT
FW VERSION.....	IDLE DISPLAY
05/30/11.....	RTC DATE
10:20.....	RTC TIME
DISABLED.....	ZBI
.....	ZBI VERSION
READY.....	ZBI STATUS
186 IN.....	NONRESET CNTR
196 IN.....	RESET CNTR1
186 IN.....	RESET CNTR2
488 CM.....	NONRESET CNTR
498 CM.....	RESET CNTR1
498 CM.....	RESET CNTR2
FIRMWARE IN THIS PRINTER IS COPYRIGHTED	



Configuration of Wireless Securities



Important • A wireless option board must be installed on your printer before you can configure the printer to communicate using a wireless radio card. See *Hardware — Wireless Print Servers* on page 23 to determine if your printer has a wireless board. See *Firmware — Wireless* on page 27 for the required firmware version.

You may configure your printer for wireless operation in the following ways:

Through the Network Setup Wizard. The Network Setup Wizard is part of the ZebraNet™ Bridge Enterprise utility. The Network Setup Wizard writes a script for you. On the last screen of the wizard, you may choose to send the script directly to your printer, or you may choose to save the script to a file. The saved file has several purposes:

- The file can be sent to the printer through any available connection (serial, parallel, USB, or wired print server).
- The file can be resent to the printer after the network settings have been restored to factory defaults.
- The file can be sent to multiple printers that will use the same network settings.



Note • To configure wired and wireless print servers on the same printer, run the program once for each print server, creating a script for the wired print server and another for the wireless print server.

The ZebraNet Bridge Enterprise utility resides on the User CD for your printer and is available through <http://www.zebra.com/software>. ZebraNet Bridge Enterprise version 1.2.5 or later is required to configure the printer correctly for use.

Through ZPL script that you write. Use the `^WX` command to set the basic parameters for security type. You can send the command through any available connection (serial, parallel, USB, or wired print server).

Refer to the *Programming Guide for ZPL, ZBI, Set-Get-Do, Mirror, and WML* for more information. A copy of the manual is available at <http://www.zebra.com/manuals> or on the User CD that came with your printer.

Through Set/Get/Do (SGD) commands. Begin with `wlan.security` to set the wireless security type. Depending on which security type that you select, other SGD commands will be necessary to specify other parameters. You can send the commands through any available connection (serial, parallel, USB, or wired print server).

Refer to the *Programming Guide for ZPL, ZBI, Set-Get-Do, Mirror, and WML* for more information. A copy of the manual is available at <http://www.zebra.com/manuals> or on the User CD that came with your printer.



Note • With printers running APL-I, APL-D, or EPL firmware, the only way to configure wireless settings is through SGD commands.



View Wireless Status through the Control Panel

After the wireless print server is configured, you may view the wireless status on the printer’s control panel in many cases.

- Printers with an LCD display text or symbols (see [LCD Link Status and Wireless Signal Indicators](#)).
- The HC100 printer does not have an LCD, so the wireless status is indicated by the control panel lights (see [HC100 Wireless Status Indicator Lights](#) on page 52).
- The ZT210, ZT220, and ZT230 printers also use control panel lights to indicate the wireless status (see [ZT210, ZT220, and ZT230 Wired and Wireless Status Indicator Lights](#) on page 53).



Note • Refer to the User Guide for your printer for specific instructions on how to use the control panel.

LCD Link Status and Wireless Signal Indicators

This section applies to printers and print engines other than the HC100, ZT210, ZT220, and ZT230 printers.

Link Status Indicator The wireless link status indicator appears at the bottom left of the LCD, providing a real-time display of the printer’s network status ([Table 10](#)).

Table 10 • Link Status Indicators

Status Indicator	Meaning
cycling through characters . o O	The wireless radio card is associated with the WLAN.
underscore —	<ul style="list-style-type: none"> • The wireless radio card is not associated with the WLAN. Verify that your printer’s wireless settings match those of the WLAN. • The firmware on the wireless radio card may need to be updated. See Supported Wireless Radio Cards on page 17 for the required firmware versions.
blank	<ul style="list-style-type: none"> • The printer is checking for a wired print server. • The printer is running a wired print server. • The wireless print server board is not installed or not installed correctly.

Wireless Signal Indicators Depending on which printer/print engine you are using, press the following key to access and scroll through the wireless signal indicators on the LCD:

- The right oval for the *PAX4*, *RPAX4*, *RXi*, *RXi HF*, and the *XiIIIPlus* printers/print engines
- Plus (+) for the *105SL*, *RZ400*, *RZ600*, *ZM400*, *ZM600*, *Xi4*, *R110Xi4* and the *ZE500* printers/print engines
- Plus (+) for the *R4Mplus*, *Z4Mplus*, and *Z6Mplus* printers (supported configurations only)
- The up arrow for the *S4M* printer

Table 11 shows the control panel indicators and messages that are associated with the wireless signal.





Table 11 • Wireless Signal Indicators

Wireless Signal Indicator	Description
SIGNAL STRENGTH and SIGNAL QUALITY	<p>When these indicators display percentages, the wireless radio card is communicating with the network. The higher the number is, the better the connection is between the printer and the network.</p> <p>If your printer indicates a signal strength but you cannot communicate with the printer from your computer, move the printer to a different location to try to get a better signal strength or signal quality. This situation could also indicate that the printer is associated with, but not authenticated with, your access point.</p>
NOISE LEVEL	<p>This number indicates any electrical interference with the wireless signal.</p> <p>If your printer cannot communicate with the network and the noise level is high, move the printer to a location that is free of interference.</p>

HC100 Wireless Status Indicator Lights

Table 12 shows the wireless status indicator lights for the HC100 printer.

Table 12 • HC100 Wireless Status Indicator Lights

Wireless Status Indicator	Meaning
<p>Steady Green</p> 	<p>The printer is associated with a wireless network. The signal strength is strong.</p>
<p>Flashing Green</p> 	<p>The printer is NOT associated with a wireless network. The signal strength is strong.</p>
<p>Steady Orange</p> 	<p>The printer is associated with a wireless network. The signal strength is weak.</p>
<p>Flashing Orange</p> 	<p>The printer is NOT associated with a wireless network. The signal strength is weak.</p>

ZT210, ZT220, and ZT230 Wired and Wireless Status Indicator Lights

Table 13 shows the wired and wireless status indicator lights for the ZT210, ZT220, and ZT230 printers.

Table 13 • ZT210, ZT220, and ZT230 Status Indicator Lights



















Status Indicator	Meaning
Printers with a ZebraNet wired Ethernet option	
 <p>STATUS PAUSE DATA SUPPLIES NETWORK</p>	<p><i>NETWORK light off</i></p> <p>No Ethernet link is available.</p>
 <p>STATUS PAUSE DATA SUPPLIES NETWORK</p>	<p><i>NETWORK light steady green</i></p> <p>A 100 Base link was found.</p>
 <p>STATUS PAUSE DATA SUPPLIES NETWORK</p>	<p><i>NETWORK light steady yellow</i></p> <p>A 10 Base link was found.</p>
 <p>STATUS PAUSE DATA SUPPLIES NETWORK</p>	<p><i>NETWORK light steady red</i></p> <p>An Ethernet error condition exists. The printer is not connected to your network.</p>
Printers with a ZebraNet wireless option	
<p>Off</p>  <p>STATUS PAUSE DATA SUPPLIES NETWORK</p>	<p><i>NETWORK light off</i></p> <p>A radio was found during power-up. The printer is attempting to associate with the network. The light flashes red while the printer associates with the network. The light then flashes yellow while the printer is authenticating with the network.</p>
<p>Red Flash</p>  <p>STATUS PAUSE DATA SUPPLIES NETWORK</p>	
<p>Yellow Flash</p>  <p>STATUS PAUSE DATA SUPPLIES NETWORK</p>	
<p>Steady Green</p>  <p>STATUS PAUSE DATA SUPPLIES NETWORK</p>	
	<p><i>NETWORK light steady green</i></p> <p>The radio is associated with your network and authenticated, and the WLAN signal is strong.</p>

Table 13 • ZT210, ZT220, and ZT230 Status Indicator Lights (Continued)

Status Indicator	Meaning
Printers with a ZebraNet wired Ethernet option	
<p style="text-align: center;">Flashing Green</p> <div style="display: flex; justify-content: space-around; align-items: center;"> <div style="text-align: center;">  STATUS </div> <div style="text-align: center;">  PAUSE </div> <div style="text-align: center;">  DATA </div> <div style="text-align: center;">  SUPPLIES </div> <div style="text-align: center;">  NETWORK </div> </div>	<p><i>NETWORK light flashing green</i></p> <p>The radio is associated with your network and authenticated, but the WLAN signal is weak.</p>
<p style="text-align: center;">Steady Red</p> <div style="display: flex; justify-content: space-around; align-items: center;"> <div style="text-align: center;">  STATUS </div> <div style="text-align: center;">  PAUSE </div> <div style="text-align: center;">  DATA </div> <div style="text-align: center;">  SUPPLIES </div> <div style="text-align: center;">  NETWORK </div> </div>	<p><i>NETWORK light steady red</i></p> <p>An WLAN error condition exists. The printer is not connected to your network.</p>

Determining the Active Print Server

Most printers can have wired and wireless print servers installed at the same time. However, only one of the installed print servers can be active at any given time.

Viewing IP Addresses and the Active Print Server

The wired and wireless print servers have different IP addresses. The printer's control panel displays the IP address of the active print server (see [View Wireless Status through the Control Panel on page 50](#)). You can view the printer's web pages and send label formats to the printer through the active print server's IP address.

The network configuration label ([Figure 12](#)) displays the IP addresses of all installed print server devices and indicates the active print server with an asterisk (circled in [Figure 12](#)). To print a network configuration label for wired print servers, see [Printing a Network Configuration Label — Internal ZebraNet 10/100 Print Server and Wireless Print Servers on page 44](#) or for wireless print servers, see [Configuration of Wireless Securities on page 49](#).

Figure 12 • Active Print Server on Sample Network Configuration Label

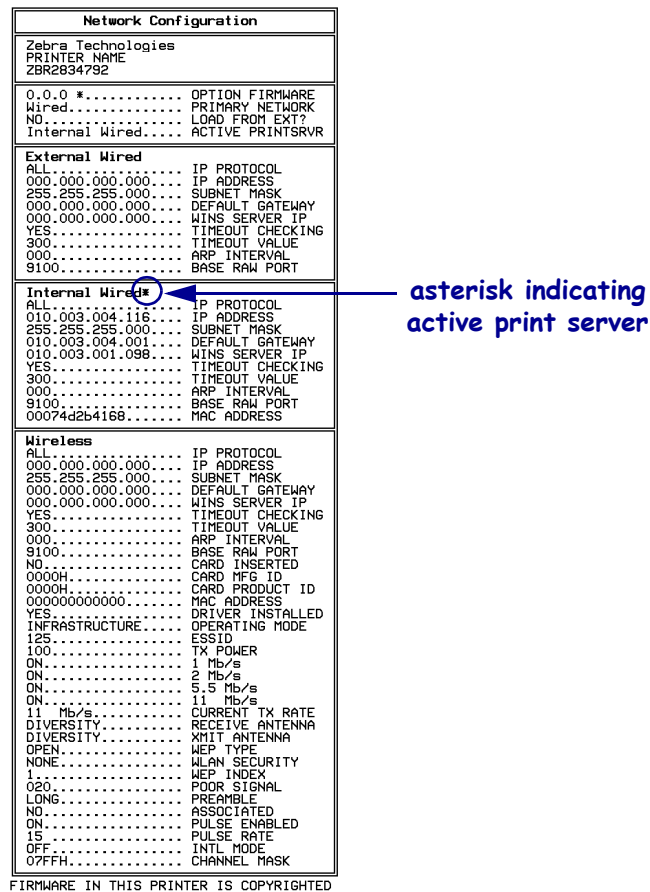

Active Device Selection

Your active print server selection is dependent on the model of printer or print engine that you have.

If your printer is a(n)...	Then...
<ul style="list-style-type: none"> • S4M • ZT210 • ZT220 • ZT230 	<p>Only one print server (wired or wireless) can be installed at a time. Thus, the print server installed is the primary print server.</p>
<ul style="list-style-type: none"> • 105SL • <i>XiIIIPlus</i> • R110Xi • R170Xi • Z4Mplus • Z6Mplus • <i>PAX4</i> • R110<i>PAX4</i> 	<p>You may select which installed device is the primary network device. The printer will try to use the primary network device as the active print server before trying the other installed options.</p> <p>These printers and print engines use X60.16.x firmware. The default for the printer is to <u>skip</u> the check for a wired print server during bootup. This makes the wireless print server the primary network device if a wireless print server is installed. To change this default and allow the wired print server to be the primary network device when it is connected, use one of the following methods to tell the printer to check for a wired print server at bootup time:</p> <ul style="list-style-type: none"> • the WIRED PS CHECK parameter on the control panel • the ^NB ZPL command <p>Table 14 identifies which device becomes the active print server under various conditions.</p>
<ul style="list-style-type: none"> • Xi4 • R110Xi4 • ZM400 • ZM600 • RZ400 • RZ600 • ZE500 	<p>These printers support the simultaneous installation of an internal, external, and a wireless print server. Even though all three print servers may be installed, only one is connected to the network and is the active print server.</p> <p>Table 15 outlines priorities and identifies which device becomes the active print server when multiple print servers are installed.</p> <p>You may select whether the wired or wireless print server will be the primary connection by using one of the following methods:</p> <ul style="list-style-type: none"> • the PRIMARY NETWORK parameter on the control panel • the ^NC ZPL command

Table 14 • Results of Check for Wired Print Server for 105SL, XiiiPlus, Z4Mplus, Z6Mplus, and PAX4 Series Printers

If the Check for Wired Print Server is set to:	Installed and Connected to a Live Ethernet Network		Then the Active Print Server will be:
	Wired	Wireless*	
Skip	X	X	Wireless
	X		Wired
		X	Wireless
Check	X	X	Wired
	X		Wired
		X	Wireless

* NOTE: A wireless option board must have an active radio that can properly associate to an access point.

Table 15 • Active Print Server Matrix for Xi4, R110Xi4, ZM400, ZM600, RZ400, RZ600, and ZE500 Printers

If the Primary Network is set to:	Installed and Connected to a Live Ethernet Network			Then the Active Print Server will be:
	Internal	External	Wireless*	
Wired	X	X	X	Internal
		X	X	External
			X	Wireless
Wireless	X	X	X	Wireless
	X	X		Internal
		X		External

* NOTE: A wireless option board must have an active radio that can properly associate to an access point.

Assigning an IP Address on any Print Server

Before you can begin working with a print server, you must get or assign an IP address for the print server device.

The four different ways to assign an IP address are:

- DHCP
- ZebraNet Bridge
- Printer Control Panel/LCD
- Telnet



Important • For specific information on the default User ID and/or default password, see [Default User ID and Password on page 41](#).

With Dynamic Host Configuration Protocol (DHCP)

If your network uses DHCP, your print server device is assigned a temporary IP address.



Note • Check with your Network Administrator to see whether your network uses DHCP.

Assigning an IP Address Without DHCP via ZebraNet Bridge

ZebraNet Bridge may be used to set the IP address. Refer to the ZebraNet Bridge Enterprise User Guide for more detailed information.

Assigning an IP address Without DHCP from the Control Panel

These steps can be used with all printers with a control panel.

To assign an IP address from the control panel (or LCD), complete these steps:



Important • Your ZebraNet 10/100 Print Server must have firmware 1.xx.x and higher and your Zebra printer must have firmware x.10 or higher with a control panel.

1. Turn on **(I)** the printer and wait until the control panel says **PRINTER READY**.
2. See [Wired Network Parameters on the LCD on page 124](#) or [Wireless Network Parameters on the LCD on page 126](#) for specific print server menu options or your printer's user guide for specific instructions on the operation of your printer.
3. You may edit any of the following network settings in order to communicate with any print server in your network environment.



Important • To change any of these settings, you need to enter the printer password. The default password is 1234.

- `ip resolution` (dynamic, permanent) The printer menu item **IP RESOLUTION** must be set to **PERMANENT** if attempting to assign the IP address from the control panel.
- `default gateway` (default setting of 000.000.000.000)
- `subnet mask` (default setting 255.0.0.0)
- `ip address` (if initial default setting is 0.0.0.0, after 2 minutes this defaults to **192.168.254.254**)
- `ip protocol` (gleaning only, RARP, BOOTP, DHCP, DHCP and BOOTP, all)

Assigning an IP Address Without DHCP via a Telnet Session

The methods used for assigning an IP address with a Telnet session are Static Route and Gleaning.



Important • This applies to any TCP/IP capable workstation/host networked with the Zebra printer. Both, the workstation/host and the print server, must be on the same network segment.

Before you can Telnet to the print server and configure it, you must first assign the print server a temporary IP address.

Static Route

To use this method, complete these steps:

1. Turn on **(I)** the printer and wait for 2 minutes to allow for the device to complete the self-test.

During this time, the print server performs an address broadcast. If no address is assigned to the unit (via DHCP or BootP), it uses a default address. The default address for print server is **192 . 168 . 254 . 254**. Print the print server configuration label to confirm the address. For details, see *Before You Begin* on page 41.

2. You can use the `route add` command to place the default IP address into the workstation's network routing table.
3. At the workstation/host command prompt (in Windows, at the DOS prompt), type:

```
route add **** "IP address of the workstation" 0  
where **** is the IP address on any print server configuration label
```



Note • The zero (0) placed at the end of the “route add” command is optional on some systems.

4. Telnet to the print server by typing:
"Telnet xxx.xxx.xxx.xxx"
The password is 1234.
5. At this point, you can alter the settings as desired. When complete, do a reset and allow the print server self-test to complete before proceeding with any communications activity.

Gleaning

A method by which the print server uses the IP address of the first ping packet that is sent to its hardware address.



Note • Gleaning works **only** on local subnets at routers. It does not pass Address Resolution Protocol (ARP) broadcasts.

To use this method, complete these steps:

1. Add an entry to the ARP table that assigns an IP address to an Ethernet (hardware) address.

The syntax for this command is:

```
arp -s <temporary ip address> <MAC Address>
```



Example • You would type: `arp -s 10.3.50.59 00-07-4d-1D-B9-86`

2. Power cycle the printer.
3. As the printer reboots, begin a continuous ping to the address assigned previously.



Note • Most UNIX systems use a continuous ping.

To use a continuous ping from a Windows host, you must issue the following command:

```
ping -t "ipaddress"
```

4. When the print server begins to respond, stop the ping activity.
In Windows, Ctrl + C halts the pinging.
5. Telnet to the print server and assign the appropriate IP address, subnet mask, and gateway, if applicable.
6. Once this is complete, reset the print server.
For details on resetting the print server, see [Reset on page 120](#).

Setting and Monitoring Alerts on any Print Server

It is important to understand the relationship between the print server and the printer when you are establishing alerts. Here are the relationships you need to be aware of:

- Non-ZebraLink-enabled printers — can only send alerts on a specific set of printer errors that are reported in the IEEE 1284 protocol.
- ZebraLink-enabled printers — ZebraLink allows for the printer to send alerts outside of the IEEE 1284 protocol.

ZebraLink Alerts

ZebraLink Alerts give you the ability to manage your Zebra printers by immediately notifying System Administrators of printer error or warning conditions, which reduces printer downtime and increases application efficiency. Using Web-based configuration tools, selected errors or warning conditions can be routed to a variety of destinations such as email messages, wireless pagers, or ZebraLink Alerts.

[Table 16 on page 63](#) shows the conditions that can trigger alerts and the possible destinations.



Table 16 • ZebraLink Alerts and Destinations

Alert Type	Error Condition
ZebraNet 10/100 Print Server Alerts	<ul style="list-style-type: none"> • On-line (condition clear) • Off-line • Paper out • Printer error
ZebraLink Alerts	<ul style="list-style-type: none"> • Media out • Ribbon out • Printhead over-temp warning • Printhead under-temp warning • Head open • Power supply over-temp • Ribbon warning (in direct-thermal mode) • Rewind full • Cut error • Printer paused • PQ job completed • Label taken • Head element out • ZBI (Zebra BASIC Interpreter) runtime error • ZBI (Zebra BASIC Interpreter) forced error • Clean printhead • Media low • Ribbon low • Replace head • Battery low • RFID error • All errors (in RFID printers only) • All errors (in non-RFID printers only) • Power on
ZebraLink Alerts Destinations	<p>Unsolicited Alert messages can be directed to the following destinations:</p> <ul style="list-style-type: none"> • Email (ZebraNet 10/100 Print Server-specific) • TCP (ZebraNet 10/100 Print Server-specific) • UDP (ZebraNet 10/100 Print Server-specific) • SNMP (ZebraNet 10/100 Print Server-specific) • Serial * • Parallel * • USB *

* Available in ZebraNet Bridge

Using ZebraNet Bridge

ZebraNet Bridge may be used to set and monitor alerts. Refer to the ZebraNet Bridge Enterprise User Guide for more detailed information.

Using WebView

This section has step-by-step instructions for setting up an alert using ZebraLink™ WebView.



Important • If you do not have a ZebraLink-enabled printer, these steps will not work.

To begin receiving notification of errors, complete these steps:

1. Open a Web browser.
2. In the Address text-box, type in the printer's IP address.
The Printer Home Page opens.

Figure 13 • Printer Home Page

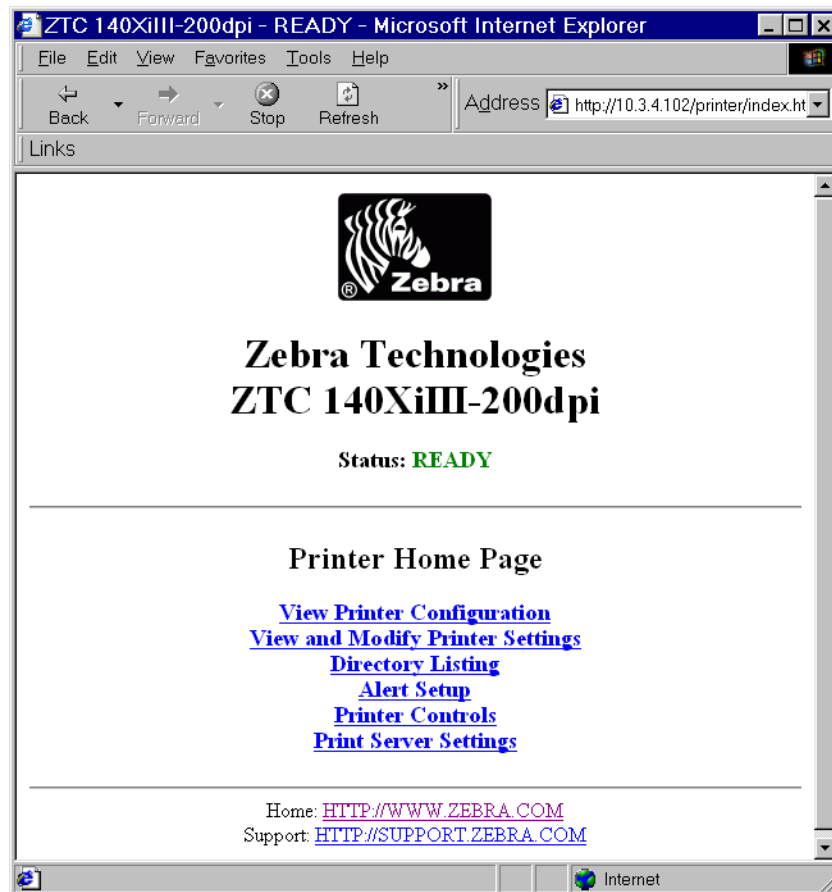

3. From the *Printer Home Page*, click Alert Setup.
The Alert Setup page shows a list of message notifications and their respective destinations (if no notifications are listed).

- To set up notification, go to the Alert Setup page and click Add Alert Message.



Important • The printer accepts only the last configuration made.

The Add Alert Message page opens.

Figure 14 • Add Alert



- Specify the condition to send, such as **HEAD ELEMENT BAD** or **PAPER OUT**.
- Set destination.
- In the SET drop-down box, select YES.
 You will be notified whenever your specific condition is detected.
- In the CLR drop-down box, select YES if you wish to be notified when the specific condition is cleared.
- If you selected email for your destination, enter a valid email address to which your messages will be sent.
 To receive email alert, you must give your print server the IP address of your mail server running SMTP. For instructions, refer to *Status and Configuration* on page 110.

10. If you selected TCP or UDP for your destination, enter the Port Number.



Important • A password is required. If you forget to enter the password, the alerts you just set are deleted.

11. Click Add Alert Message.
12. To save current settings, click Save Printer Setting.
13. Enter the password and click Save Current Configuration.

Checking Print Server Configuration Settings

This section provides steps on how to check the print server configuration settings using ZebraNet Bridge and a browser.

Using ZebraNet Bridge

ZebraNet Bridge may be used to check the print server configuration settings. Refer to the ZebraNet Bridge Enterprise User Guide for more detailed information.

Using WebView

This section provides steps on how to check any print server configuration settings using its Web pages.

To access the print server settings, complete these steps:

1. Open a Web browser.
2. In the Address text-box, type your printer's IP address, and then press Enter.
Your browser page looks similar to [Figure 15](#).

Figure 15 • Browser View

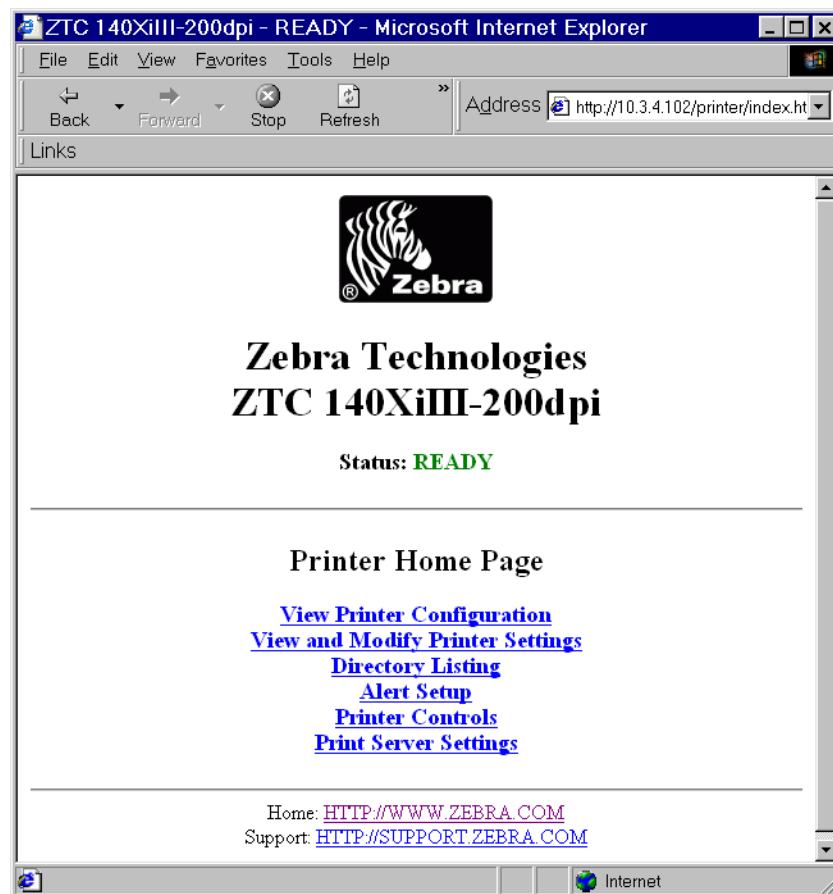

Note • Your printer firmware determines how this page looks. This page is from a printer with firmware x.15 and above.

3. From the Printer Home Page, click Print Server Settings.
The default User ID and password are required.



Important • For specific information on the default User ID and/or default password, see *Default User ID and Password* on page 41.

The Print Server Configuration Page opens.

Figure 16 • Print Server Configuration Page

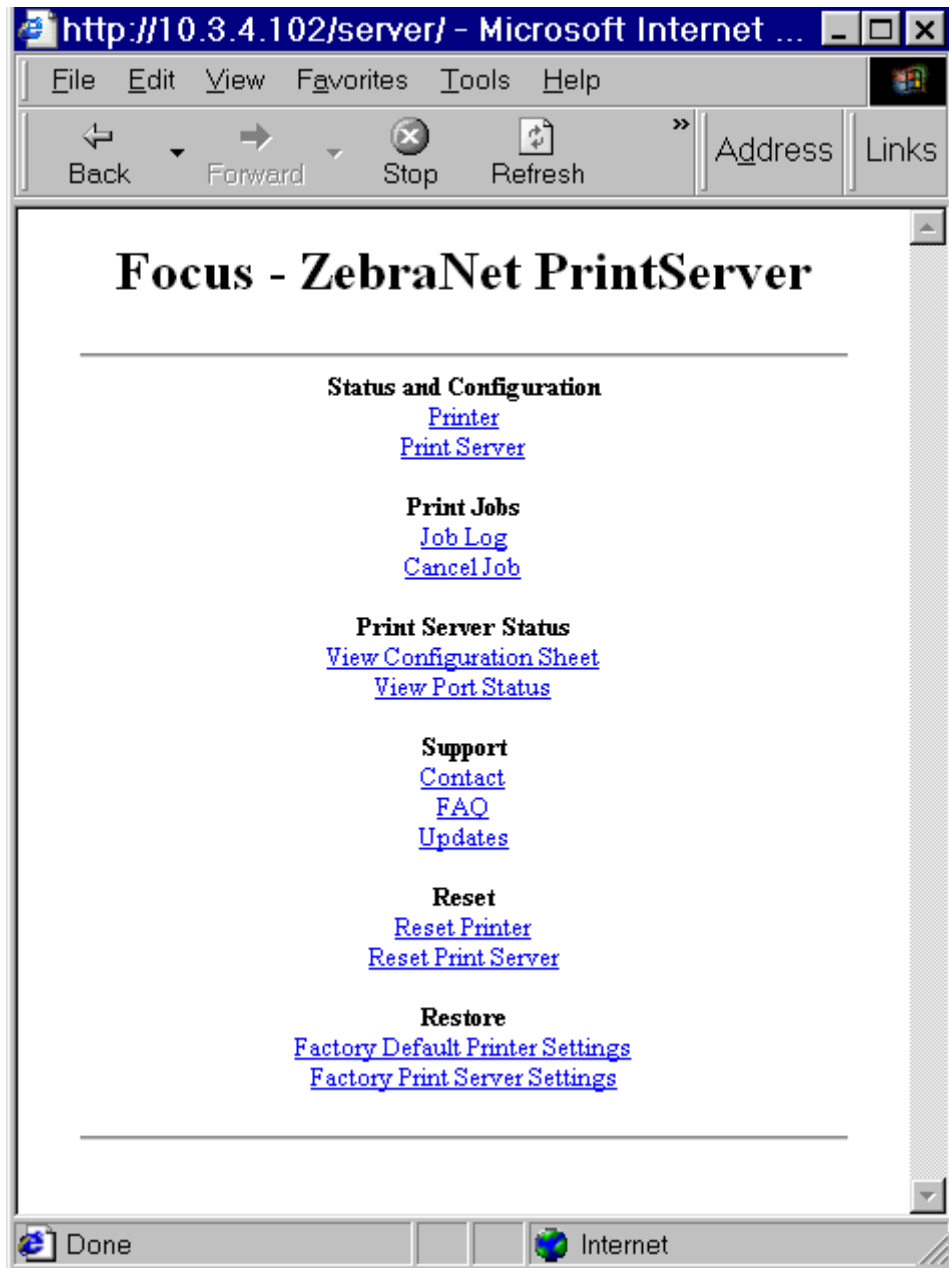

4. From the Print Server page, click Print Server.
The Print Server Configuration page opens.

Figure 17 • Access Settings

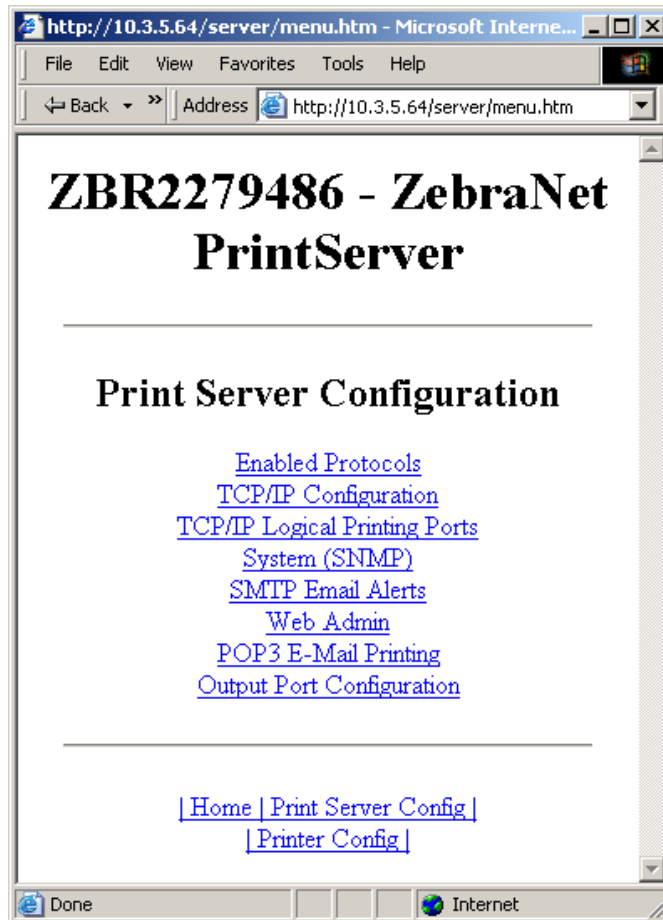

Enabling Protocols

This section contains directions for accessing protocols using WebView.

Using WebView

To enable protocols using WebView, complete these steps:

1. Open a Web browser.
2. In the Address text-box, type your printer's IP address, then press Enter.
Your browser page looks similar to [Figure 18](#).

Figure 18 • Address Text-Box

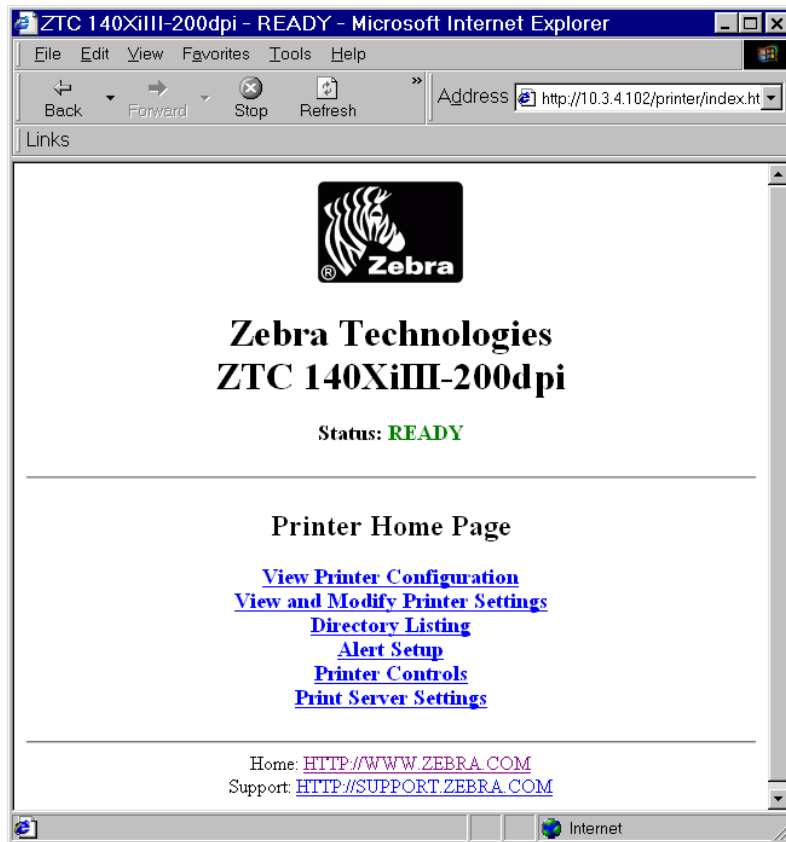

3. From the Printer Home Page, click Print Server Settings.
The default User ID and password are required.



Important • For specific information on the default User ID and/or default password, see *Default User ID and Password* on page 41.

4. From the Print Server page, click Print Server.
The Print Server Configuration page opens.

Figure 19 • Print Server Configuration

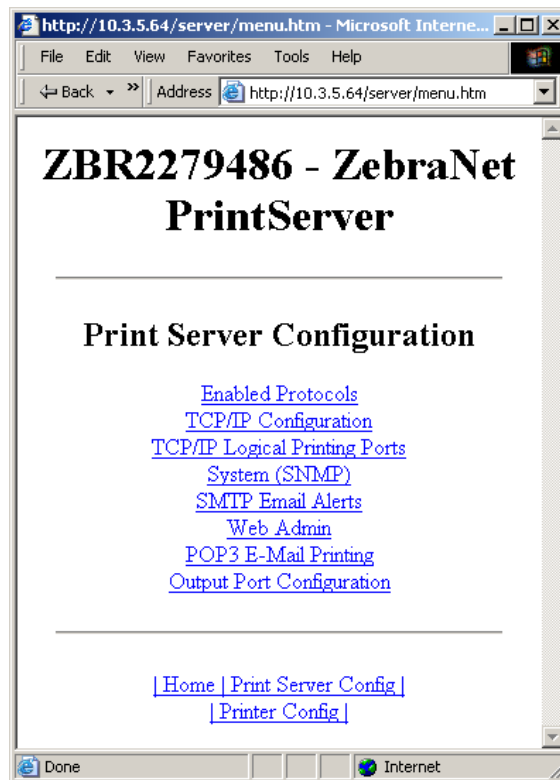

5. From the Print Server Configuration page, click Enabled Protocols.
The Protocol Configuration page opens.

Figure 20 • Protocol Configuration

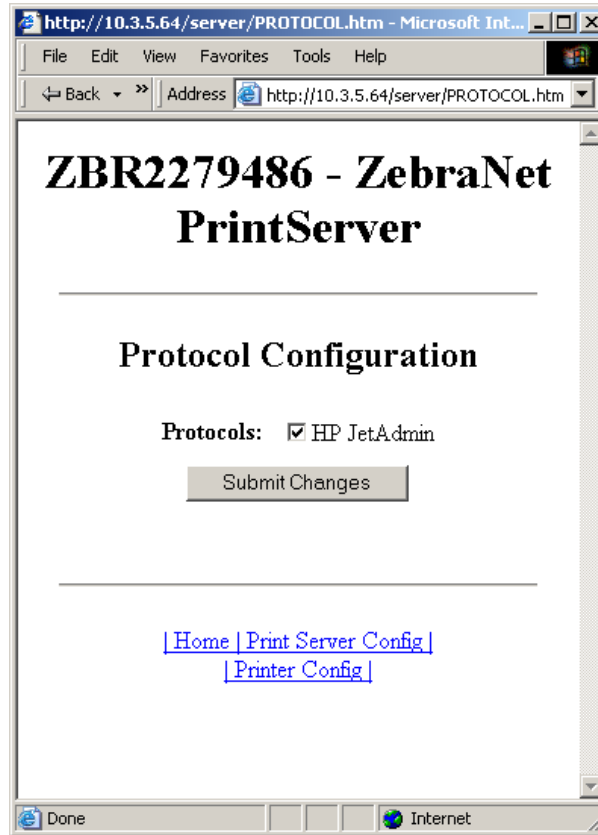

6. Select the protocols you want to enable, then click Submit Changes.
You get a confirmation to reset the unit for changes to take place.

Defaulting ALL Print Servers

Using WebView

To default the print server to factory settings using WebView, complete these steps:

1. From the ZebraNet PrintServer view, click Factory Print Server Settings.
The Restore to Factory Defaults page opens:

Figure 21 • Restore to Factory Defaults

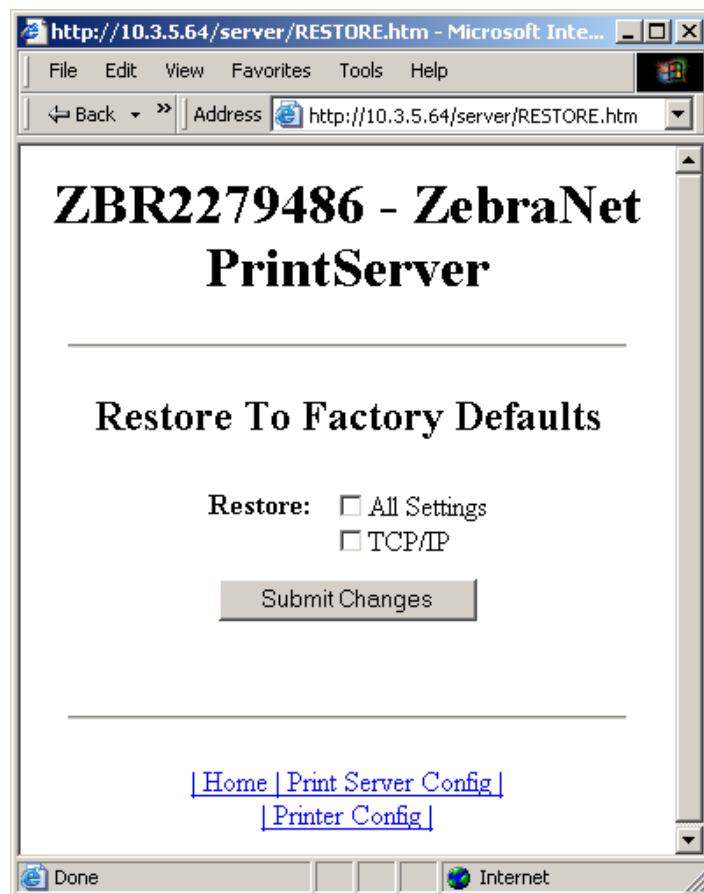

2. Enable the check box for the settings you want to reset, and click Submit Changes.



Important • During the reset cycle, the web pages are unavailable. Upon completion, check the print server IP address as it may have changed during the reset cycle.

Using ZebraNet Bridge

ZebraNet Bridge may be used default the print server to factory settings. Refer to the ZebraNet Bridge Enterprise User Guide for more detailed information.

Using a ZPL Command

Issue the ZPL command shown immediately below or refer to the *ZPL II® Programming Guide for ZPL II, ZBI 2, Set-Get-Do, Mirror and WML* for further details.

```
^XA^JUN^XZ
```



Note • To download a copy of either of the guides mentioned above, visit the Zebra web site at: www.zebra.com/manuals.



Defaulting the ZebraNet 10/100 Print Server on the 105SL, S4M, PAX4 and External Devices



The Test button is accessed via a small recessed hole on the back of the external ZebraNet 10/100 Print Server device (see [Figure 3 on page 33](#)). To press the Test button, you need to insert something small into the hole, like the end of a paperclip.

For the internal ZebraNet 10/100 Print Server device, the Test button is located on the back of printer.

To default the ZebraNet 10/100 Print Servers to factory settings using the Test button, complete these steps:



Note • You must have an active network cable connected to the external ZebraNet 10/100 Print Server device to default the device using the Test button.

1. Turn off (O) the printer.
2. With the printer turned off, press and hold the Test button on the ZebraNet 10/100 Print Server device and turn on (I) the printer.
3. The status indicator tells you when ZebraNet 10/100 Print Server has been reset to factory defaults, as follows:
 - If an active network cable is connected to the ZebraNet 10/100 Print Server, the status indicator turns solid green.
 - If there is **not** an active network cable connected to the ZebraNet 10/100 Print Server, the status indicator flashes red.
4. Release the Test button.

For more details on status indicators, see [External ZebraNet 10/100 Print Server Network Status and Status Indicators on page 130](#).



Defaulting the Wireless Print Server on the S4M

1. From the control panel, enter Setup Mode. (Refer to the User Guide for your printer for specific instructions on how to use the control panel.)
2. Scroll to level 3 parameter **DEFAULT NET**.
3. Press ENTER twice to confirm defaulting.
4. Press Menu to exit the Setup Mode.
5. If necessary, press the up or down arrow to select **Yes**.
6. Press Enter to save changes and exit Setup mode.



Defaulting the Print Servers on the ZM400 and ZM600 Printers



To default the print server to factory settings using the control panel on the ZM400 or ZM600 printers, complete these steps:

1. From the control panel, press Setup/Exit two times.
2. Press Plus (+ button) five times.
The control panel will read **DEFAULT NET**.
3. Press Setup/Exit to save the change.
After the printer defaults all settings, the control panel will show **PRINTER READY**.



Defaulting the Print Servers on the ZP Series, LP/TLP 2824 Plus, and G-Series Printers



To default the print server to factory settings, complete these steps:



Note • Be sure to count the number of LED flashes.

1. Hold Feed until you see a sequence of four green flashes.
2. Release Feed and the LED will immediately flash amber once.



Important • If you do not press Feed the second time (in [step 3](#) below), you will default the **printer** only.

3. Press and hold Feed again to enter the Default submenu.
The flash sequences represent various devices to default:
 - One green flash: Defaults the print server only
 - Two green flashes: Defaults the printer only
 - Three green flashes: Defaults both, the printer and the print server
4. Release Feed when you see the flash sequence that corresponds to the desired default.



Defaulting the Print Servers on the HC100 Printers

To default the print server to factory settings, complete these steps:

1. Press and hold Feed for two seconds.



Note • Be sure to count the number of LED blinks. The three blink sequence defaults **only** the print server parameters while the four blink sequence defaults **all** of the printer parameters.

2. Wait for the three blink sequence of the Error/Status LED.
3. Release Feed.



Defaulting the Print Servers on the 105SL, PAX4, Xi4, and ZE500 Printers

To default the print server to factory settings, complete these steps:

1. From the control panel, press Setup/Exit two times.
2. Press Plus (+) five times.
The control panel will read **DEFAULT NET**.
3. Press Next/Save to save the change.
The control panel will read **PRINTER READY**.



Defaulting the Print Servers on the ZT210 and ZT220 Printers

1. Turn off (O) the printer.
2. Press and hold the Pause and Cancel keys and turn on (I) the printer.
3. Hold the Pause and Cancel keys until the first status indicator light turns off.
4. Which type of print server do you have?

If you have a...	Then, you will see one of the following conditions...
Wired print server	<ol style="list-style-type: none"> a. Steady green Network status indicator: A 100Base-T link was found. b. Steady yellow Network status indicator: A 10Base-T link was found. c. Steady red Network status indicator: No network link was found.
Wireless print server	<ol style="list-style-type: none"> a. Steady green Network status indicator: A wireless network was found. Your print server has successfully associated with and been authenticated by the wireless network. b. Steady red Network status indicator: No network link was found. <p> Note • If you reset your wireless print server, the ESSID setting will change to “125” and all encryption and authentication settings will be disabled. The wireless print server settings should be reconfigured to match your wireless network settings.</p>

For more information on status indicators, see [ZT210, ZT220, and ZT230 Wired and Wireless Status Indicator Lights](#) on page 53.



Defaulting the Print Servers on the ZT230 Printers

Refer to the User Guide for your printer for specific instructions on how to use the control panel.



Notes • _____

Printing Queues

This section provides information and instructions on configuring your printer for use with a BSD or System V Queue.

Contents

Berkeley Software Distribution (BSD)-Style Print Queue	80
Configuring the Print Queue	80
System V Queue Installation	81
Configuring Operating System V Queue for ZebraNet Printing	81
Prerequisites	81
UNIX Configuration	81

Berkeley Software Distribution (BSD)-Style Print Queue

BSD is a version of the UNIX OS that distributes software that includes TCP/IP.

Configuring the Print Queue

For remote BSD-style LPD printing, add the print server as a remote printer in the `/etc/printcap` database to each host printing to any print server. You can add printcap options as needed. If you are unfamiliar with these options, consult the printer documentation.



Important • You must be logged in as `root`.

The entry looks similar to this:

```
local_print_queue_name|[printer_model_and_manufacturer]:\  
:lp=:mx#0:rm=ZebraNet_name:\  
:rp=remote_print_queue_name:\  
:sd=path_to_spool_directory:lf=just_log_file_name
```

`local_print_queue_name` — This defines the name of the printcap entry. It is used by the LPR/LPD utilities to specify which printcap entry is being referenced. Additional printcap entries can be added as needed for different queue types. Each entry must have a unique `local_print_queue_name` and a different spool directory to work properly. When you are ready to print, use the `local_print_queue_name` that matches the data type of the file to be printed.

`ZebraNet_name` — This is the name (alias) of the ZebraNet print server. This must be the same name as entered in the `/etc/hosts` file or your NIS or DNS system. An IP address may also be used here.

`remote_print_queue_name` — This entry determines the ZebraNet port where the print job will be printed and optionally specifies ASCII printing that must end for LF1.

`path_to_spool_directory` — This is the path to a directory where the print jobs will be spooled for this queue. You must create a unique spool directory for each printcap entry.

`log_file_name` — This is the path to a file where error information from the LPD will be logged.



Example • Your printcap entries might look similar to this:

```
Ascii_files|form.feed.Queue_on_Port_1:\  
:lp=:mx#0:rm=pserver1:rp=MYQUEUELF1:\  
:sd=/usr/spool/myqueueelf1:\  
:lf=/usr/spool/myqueueelf1/queue.log
```



Important • Each printcap entry must have a different spool directory to work properly.

System V Queue Installation

Configuring Operating System V Queue for ZebraNet Printing

This section describes the configuration of the printing system on the UNIX operating system. For clarity and brevity, the following specific names are used to represent general devices or concepts.

`lj4` — The local queue name on the UNIX system to which you want print server print jobs directed.

`ZEBRAPRINTER` — The host name or IP address of the remote system that is the print server device. For example, to Telnet to any print server and invoke the print server configuration utility, you would enter:

```
Telnet ZEBRAPRINTER
```

A host name is not required for the print server — the IP address can be used.

`yourqueuename` — This is the name of the queue on the ZebraNet and must end with `LF1`.

Prerequisites

Before you proceed, the following prerequisites must be met:

- The name `ZEBRAPRINTER` and the IP address assigned to the print server are in the `/etc/hosts` file on the UNIX system.
- The LPD must be running on the UNIX system.

UNIX Configuration

To configure the UNIX machine so users can spool print jobs to the PCL print queue on the ZebraNet named `ZEBRAPRINTER`, complete these steps:

1. Log in to the UNIX machine as root.

2. Type:

```
lpsystem -t bsd ZEBRAPRINTER
```

3. Type:

```
lpadmin -p lj4 -s ZEBRAPRINTER!yourqueuename - I any
```

4. Type:

```
accept lj4
```

5. Type:

```
enable lj4
```

6. Try printing by typing the command:

```
lp -d lj4 [filename]
```



Notes • _____

Using Printing Protocols

In this section, you are given steps to set up your print server to support **Internet Printing Protocol (IPP)** and **File Transfer Protocol (FTP)**.

Contents

IPP	84
FTP	85



IPP



Important • You must have IPP support on your system.

Internet Printing Protocol (IPP) is an application-level protocol used for distributed printing over the Internet. Using IPP from any standard IPP client, you can transfer jobs to a printer that is connected to either your external ZebraNet 10/100 Print Server or your internal ZebraNet 10/100 Print Server for S4M, 105SL, PAX4, and XiIIIPlus.



Important • IPP support is not available on all 10/100 Internal Print Server printers. To be certain you are running the latest version of firmware, visit <http://www.zebra.com>.

To set up your 10/100 Print Server to support IPP, complete these steps:

1. Open a browser.
2. Enter the 10/100 Print Server IPP URL as follows:
`http://xxx.xxx.xxx.xxx:631/ipp/port1`
xxx.xxx.xxx.xxx = the IP address of the 10/100 print server device
:631 = a fixed value
/ipp = a fixed string designating IPP
/port1 = a fixed value



Example • Your address might look like this:

```
http:198.60.248.120:631/ipp/port1
```

FTP

Embedded within the print server is an FTP server application that processes file transfers from a host computer to the printer.

If the printer is on a network, label formats can be generated and data can be transferred without setting up a print queue.

To send information to the printer, perform these steps:

1. Open a command prompt and type:

```
ftp <IP of PS>
```



Example • If the IP address of your print server device is 12.3.4.123, you would type:

```
ftp 12.3.4.123
```

This opens a session with the FTP server.

2. Type your user name and press Enter.



Note • By default, there is no user name.

3. Type:

```
put < filename>
```

where filename is the location and filename of your ZPL script

This transfers the file to the printer, and the printer generates a label.

4. To terminate the FTP session, type:

```
quit
```



Notes • _____

ZebraLink WebView

This section describes the ZebraLink WebView functionality on your ZebraLink-enabled printer with a print server.

Contents

WebView	88
Home Page	88
View Printer Configuration	90
View and Modify Printer Settings	91
Network Communications Screens	98
Directory Listing	103
Printer Controls	108

WebView

WebView provides the System Administrator or user complete, easy, one-step control over the printing environment. It provides real-time configuration, control, and monitoring capabilities with the convenient graphic interface of a Web browser.

The Web pages returned by Zebra printers are not static. They contain real-time information about the printer's present state of operation, including on-line status, error conditions, and all printing parameters.

Home Page



Note • To access the printer's Web page, you need the IP address. For instructions on getting the IP address, see [Assigning an IP Address on any Print Server on page 58](#).

The Home Page is the first Web page that opens. It is a page with a menu of hyperlinks. Each hyperlink allows you to make modifications to the printer, print server, and network settings. The other changeable settings on the Home Page include:

- Network Status, Error, and Warning reports
- ZebraNet print server configuration
- Printer settings
- Directories of objects stored in Flash memory and RAM devices
- Objects, stored fonts, images, programs, and formats
- Zebra Technologies support and home pages

To open the WebView of your printer, complete these steps:

1. Open a Web browser.
2. In the Address text-box, type your printer's IP address, and press Enter.
The Printer Home Page opens.

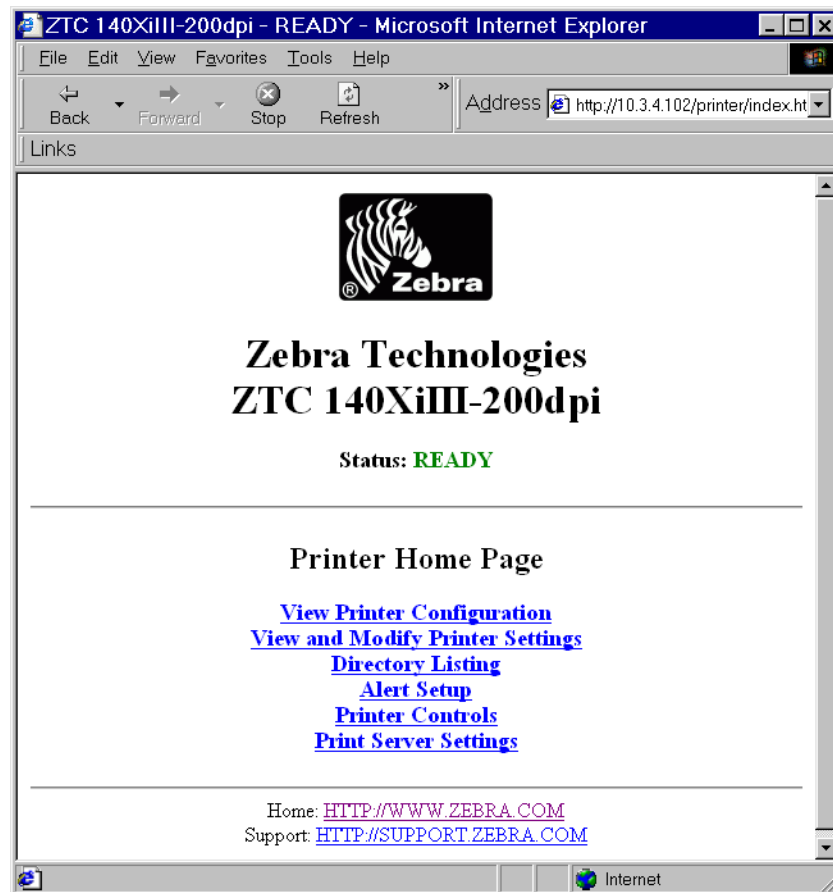
Figure 20 • Printer Home Page

View Printer Configuration

The View Printer Configuration menu option provides accurate, up-to-the-minute information on the printer's current state. An administrator can conveniently find any information on the Virtual Configuration Label and also check on the status of printer ports.

To see the View Printer Configuration menu option, complete these steps:

1. From the Printer Home Page, click View Printer Configuration.
The WebView displays the configuration settings.

Figure 21 • Configuration Settings

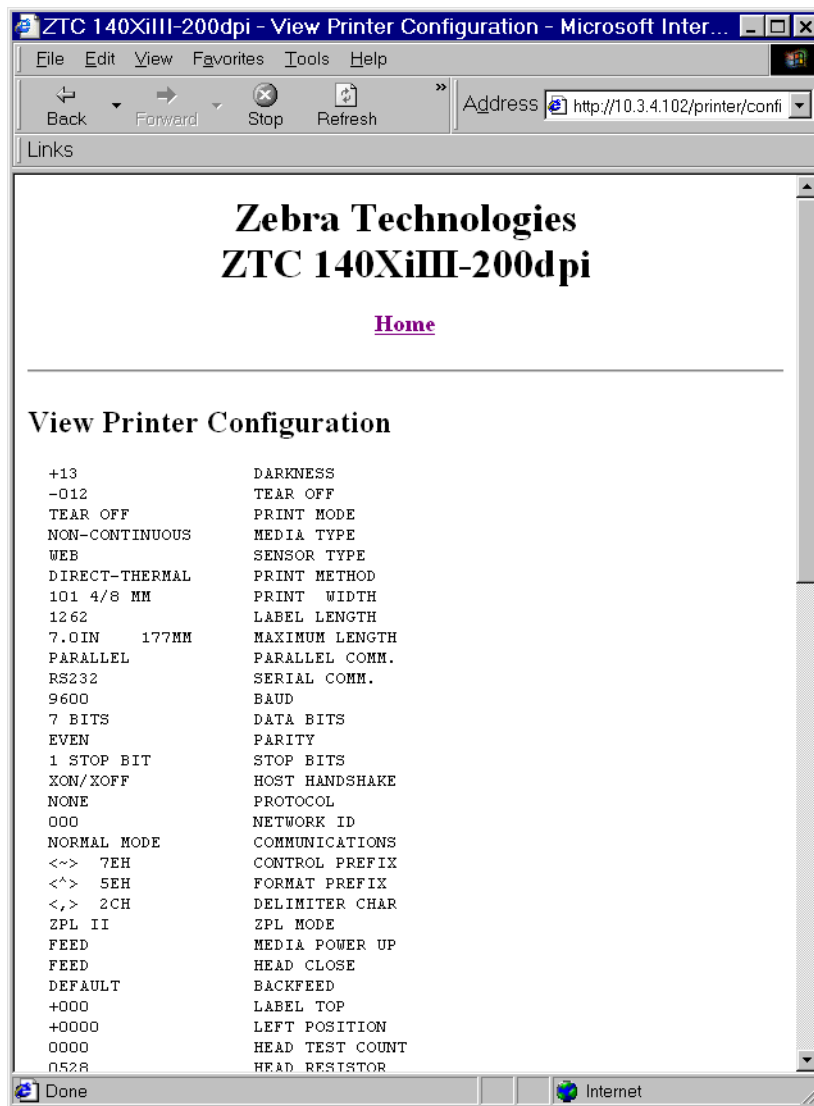

2. To update the printer information from this view, click Refresh and the printer sends current information to the Web browser.
3. When you are finished reviewing:

If...	Then...
You want to return to the Home page	Click the Home link.
You want to print a label	Scroll to the bottom of this page and click Print Label.

View and Modify Printer Settings

This section provides you with steps for accessing and modifying printer settings with a ZebraLink-enabled printer. It also provides illustrations of the various pages you can access.

To apply changes made in this section, the default User ID and password are required.



Important • For specific information on the default User ID and/or default password, see [Default User ID and Password on page 41](#).

To view and modify printer settings, complete these steps:

1. From the Printer Home Page, click View and Modify Printer Settings.
The View and Modify Printer Settings page opens.

Figure 22 • View and Modify Printer Settings

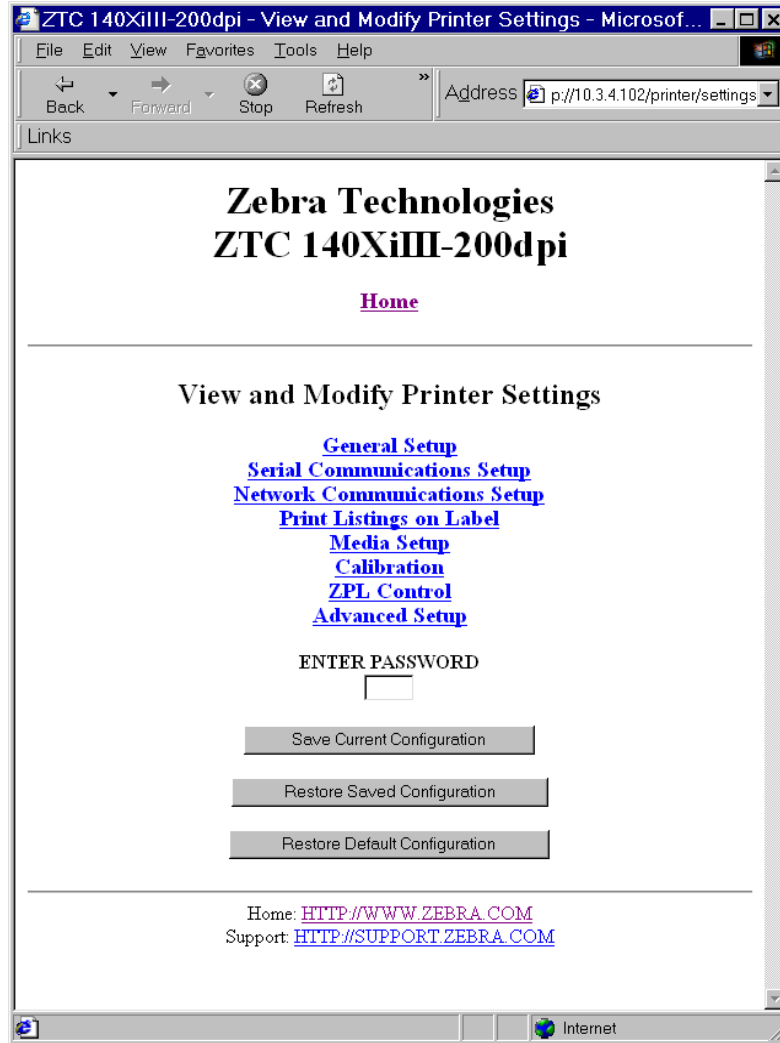

2. On the View and Modify Printer Settings page, you have a menu to choose from.



Note • Some options are not available on all printers.

Table 17 • View and Modify Printer Settings Menu Options

General Setup

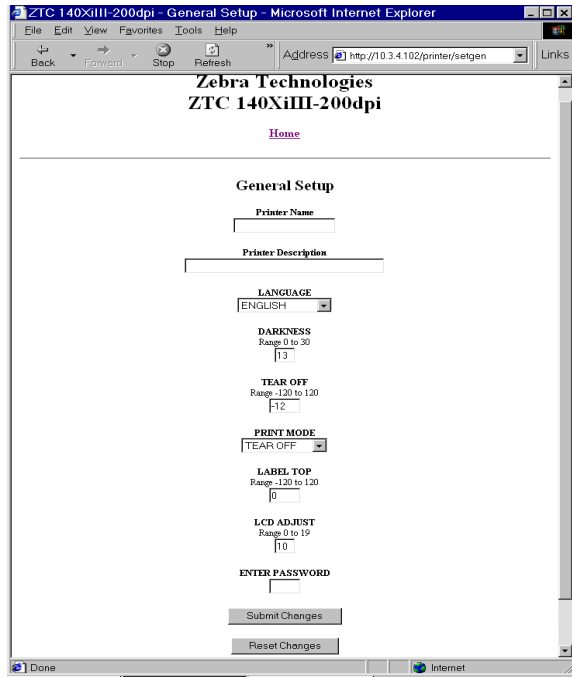

Serial Communications Setup

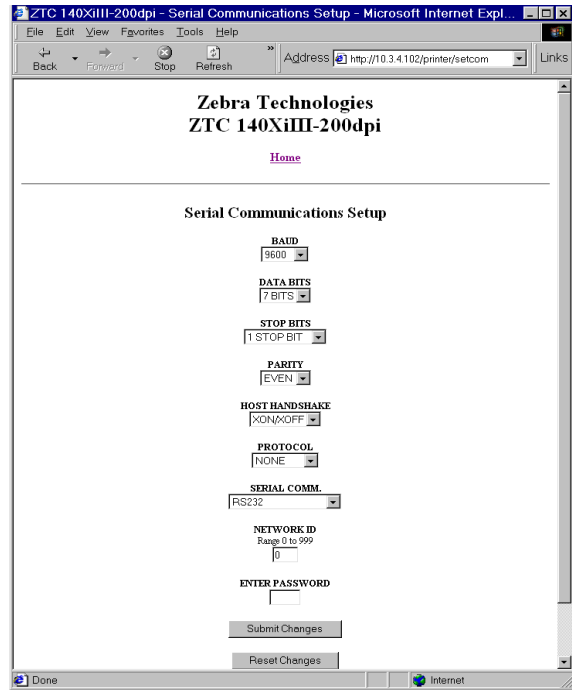
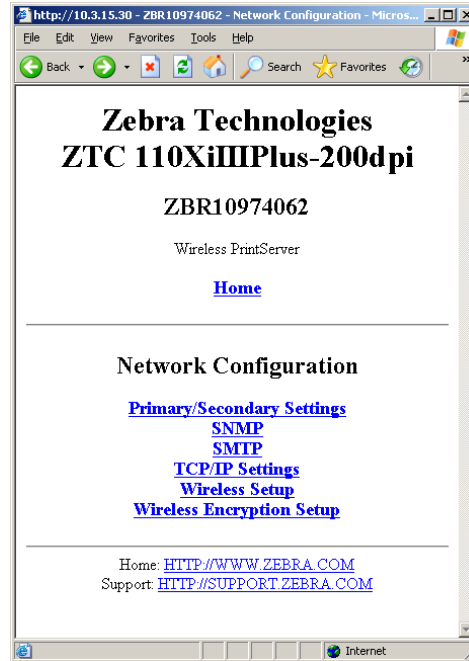

Table 17 • View and Modify Printer Settings Menu Options (Continued)

Network Communications Setup



Print Listings on Label



Table 17 • View and Modify Printer Settings Menu Options (Continued)

RFID Setup
 (RFID Printers/Print Engines
 only)

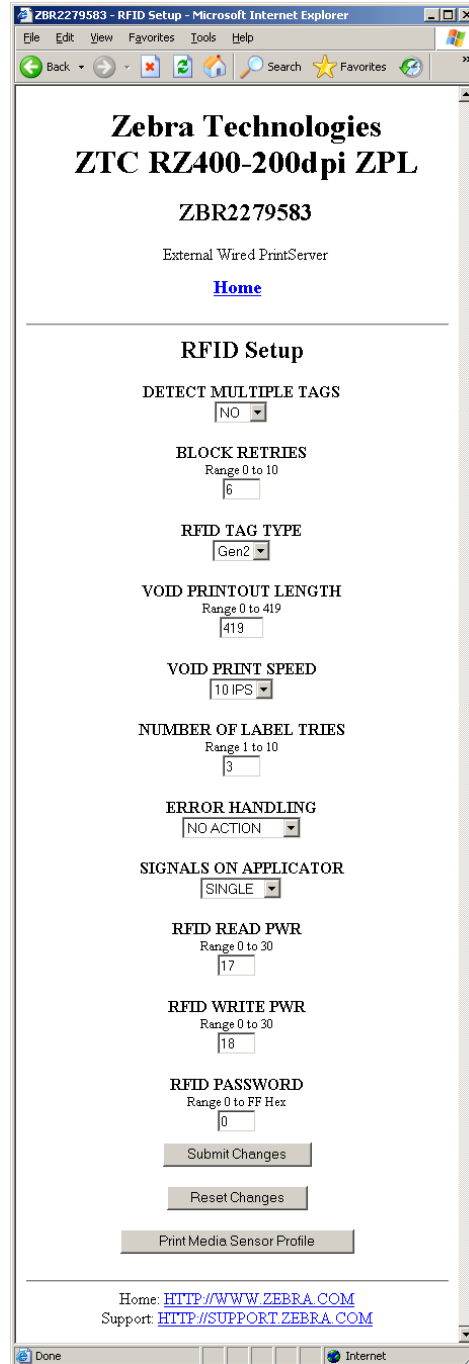
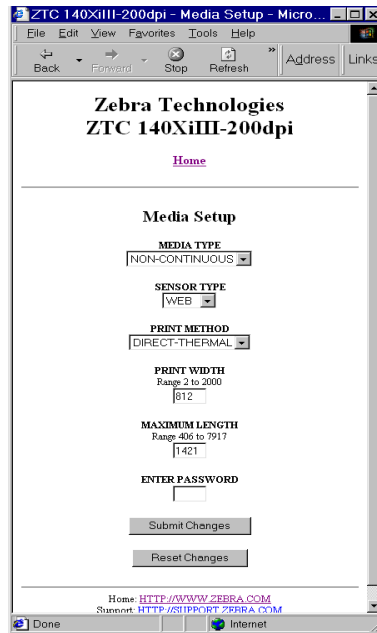

Table 17 • View and Modify Printer Settings Menu Options (Continued)

Media Setup



Calibration

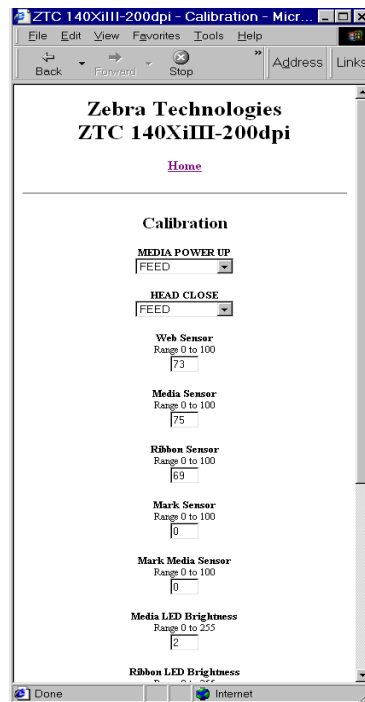
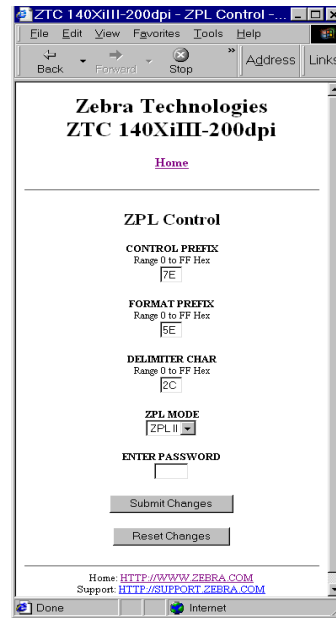
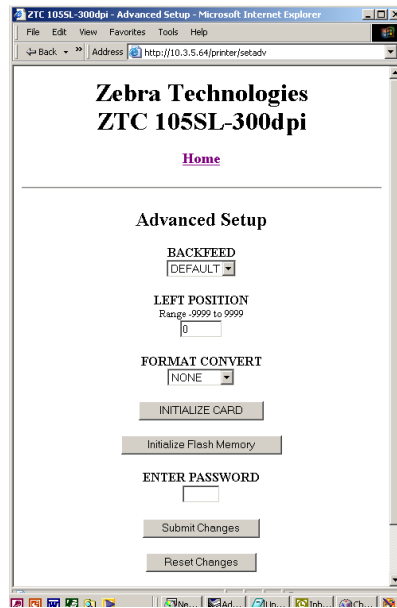

Table 17 • View and Modify Printer Settings Menu Options (Continued)

ZPL Control



Advanced Setup



Network Communications Screens

This section shows the screens that appear when you click on the menu items on the Network Communications menu.

To access the Network Communications menu, complete these steps:

1. From the printer home page, click **View and Modify Printer Settings**.

The printer prompts you for a password.

2. Enter the password for your printer. The default password is **1234**.

3. Click **Submit Changes**.

The following statement appears:

Access Granted. This IP Address now has admin access to the restricted printer pages. Please Click here to proceed

4. Click on the statement.

The View and Modify Printer Settings page displays (see [Figure 22 on page 92](#)).

5. Click **Network Configuration**.

The Network Configuration Menu displays. [Table 18](#) shows the screens that appear when you click on the menu selections on this page and describes some of the items that may need clarification.

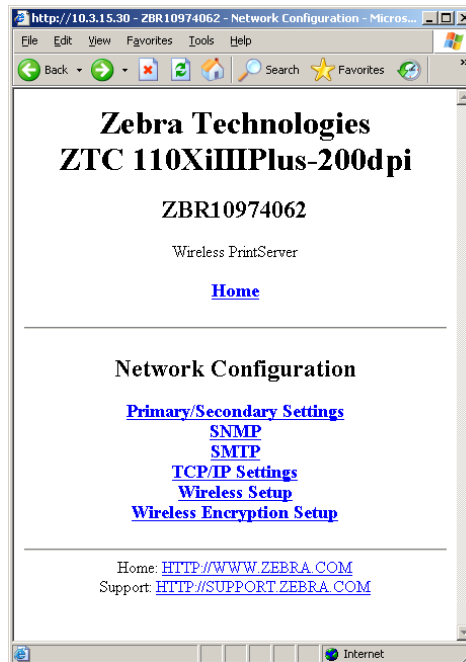
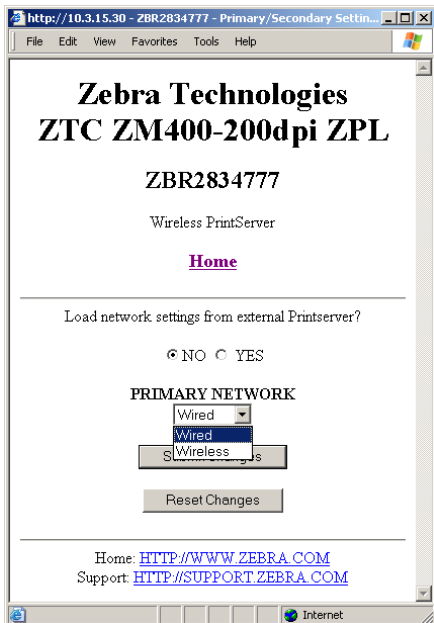

Table 18 • Subscreens: Network Communications Setup

Primary/Secondary Settings
X60.15.x



Xi4, R110Xi4, ZM400, ZM600, RZ400, RZ600, and ZE500



SNMP

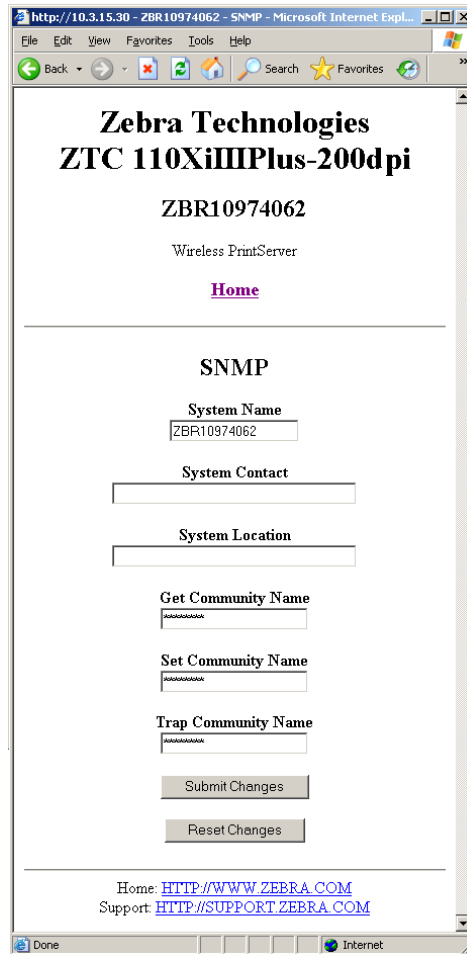

Table 18 • Subscreens: Network Communications Setup (Continued)

SMTP

Zebra Technologies
ZTC 140XiIIIPlus-200dpi
ZBR11304858
Wireless PrintServer
[Home](#)

SMTP

SMTP Server Address

Print Server Domain

Home: [HTTP://WWW.ZEBRA.COM](http://www.zebra.com)
Support: [HTTP://SUPPORT.ZEBRA.COM](http://support.zebra.com)

TCP/IP

X60.15.x and ZSPx

Zebra Technologies
ZTC 110XiIIIPlus-200dpi
ZBR10974062
Wireless PrintServer
[Home](#)

TCP/IP Settings

Setting	Wired	Wireless
IP ADDRESS	<input type="text" value="000.000.000.000"/>	<input type="text" value="010.003.015.030"/>
IP PROTOCOL	<input type="text" value="ALL"/>	<input type="text" value="DHCP"/>
SUBNET MASK	<input type="text" value="000.000.000.000"/>	<input type="text" value="000.000.000.000"/>
DEFAULT GATEWAY	<input type="text" value="000.000.000.000"/>	<input type="text" value="000.000.000.000"/>
WINS SERVER IP	<input type="text" value="000.000.000.000"/>	<input type="text" value="000.000.000.000"/>
TIMEOUT CHECKING	<input type="text" value="YES"/>	<input type="text" value="YES"/>
TIMEOUT VALUE	<input type="text" value="300"/>	<input type="text" value="300"/>
ARP INTERVAL	<input type="text" value="0"/>	<input type="text" value="0"/>
BASE RAW PORT	<input type="text" value="9100"/>	<input type="text" value="9100"/>

CLIENT ID ENABLED

CLIENT ID TYPE

CLIENT ID PREFIX

CLIENT ID SUFFIX

Home: [HTTP://WWW.ZEBRA.COM](http://www.zebra.com)
Support: [HTTP://SUPPORT.ZEBRA.COM](http://support.zebra.com)

Table 18 • Subscreens: Network Communications Setup (Continued)

TCP/IP
 Xi4, R110Xi4, ZM400, ZM600, RZ400, RZ600, and ZE500

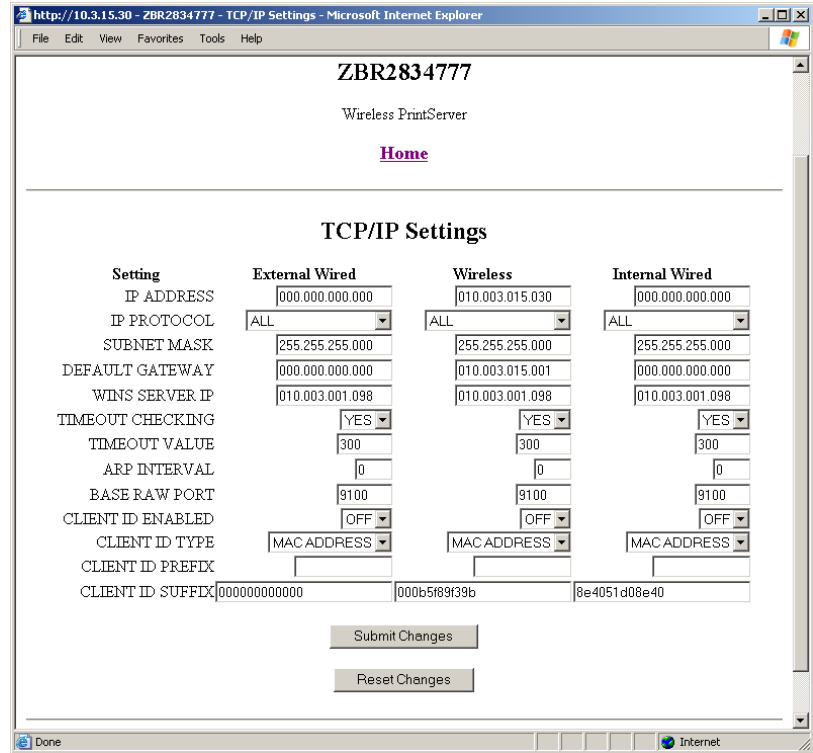

Table 18 • Subscreens: Network Communications Setup (Continued)

Wireless Setup

Zebra Technologies
ZTC 110XiIIIPlus-200dpi
ZBR10974062
Wireless PrintServer
[Home](#)

Wireless Setup

CARD INSERTED
 YES

SIGNAL STRENGTH
98

SIGNAL QUALITY
87

NOISE LEVEL
0

CARD MFG ID
351

CARD PRODUCT ID
10

CARD FIRMWARE
5.60.21

MAC ADDRESS
00:0e:84:c4:f8:76

ESSID
125

OPERATING MODE
INFRASTRUCTURE

TX POWER
100

TX RATE
 1 Mb/s
 2 Mb/s
 5.5 Mb/s
 11 Mb/s

POOR SIGNAL
Range 0 to 99
20

PREAMBLE
LONG

ADHOC AUTO MODE
OFF

ADHOC CHANNEL
Range 1 to 16
1

CHANNEL MASK
Range 1 to FFFF Hex
7FF

ROAM INTERVAL
20

ROAM SIGNAL
50

PULSE ENABLED
ON

PULSE RATE
Range 5 to 300
15

Home: [HTTP://WWW.ZEBRA.COM](http://www.zebra.com)
Support: [HTTP://SUPPORT.ZEBRA.COM](http://support.zebra.com)

Wireless Encryption Setup

Zebra Technologies
ZTC 110XiIIIPlus-200dpi
ZBR10974062
Wireless PrintServer
[Home](#)

Wireless Encryption Setup

WLAN SECURITY
WEP 128-BIT

WEP INDEX
1

ENCRYPTION KEY STORAGE
HEX

WEP TYPE
OPEN

ENCRYPTION KEY 1

ENCRYPTION KEY 2

ENCRYPTION KEY 3

ENCRYPTION KEY 4

WLAN SECURITY USERNAME
wpa_leap_user

WLAN SECURITY PASSWORD

WPA PSK

Home: [HTTP://WWW.ZEBRA.COM](http://www.zebra.com)
Support: [HTTP://SUPPORT.ZEBRA.COM](http://support.zebra.com)

Directory Listing

The directory page provides a listing of all file system devices (B:, E:, R:, Z:). The size, name, and location of each stored object appears.

Buttons are available to perform file management operations on the objects. The file management operations include:

- Delete object — Not available for objects in read-only memory (Z:).
- Copy object to a new name and/or device — Not available for objects in read-only memory (Z:).
- Run a ZBI program — Available only if the object is a stored ZBI program. For details, see the *Programming Guide for ZPL II, ZBI 2, Set-Get-Do, Mirror, and WML*.

To view the Directory Listing, complete these steps:

1. From the Printer Home Page, click **Directory Listing**.

This page opens.

Figure 23 • Directory Listing

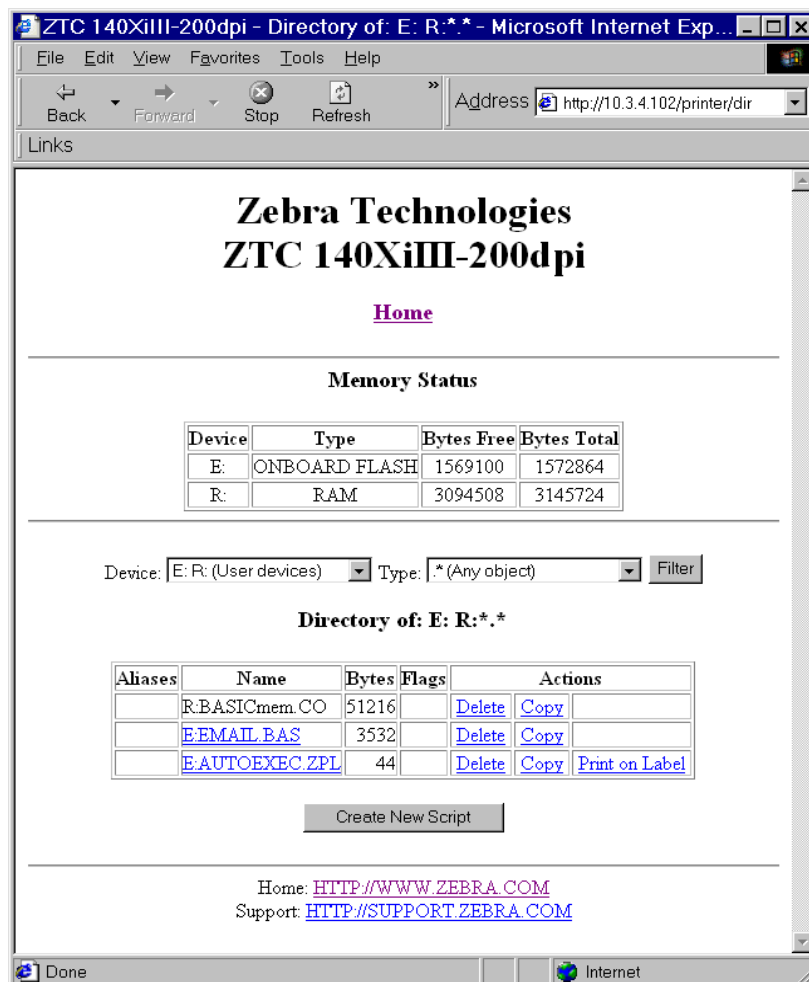

There are several fields to select in this view.

To create a new item on the Directory Listing screen, complete these steps:

1. From the Printer Home Page, click **Directory Listing**.
The Directory Listing screen displays.

Figure 24 • Directory Listing

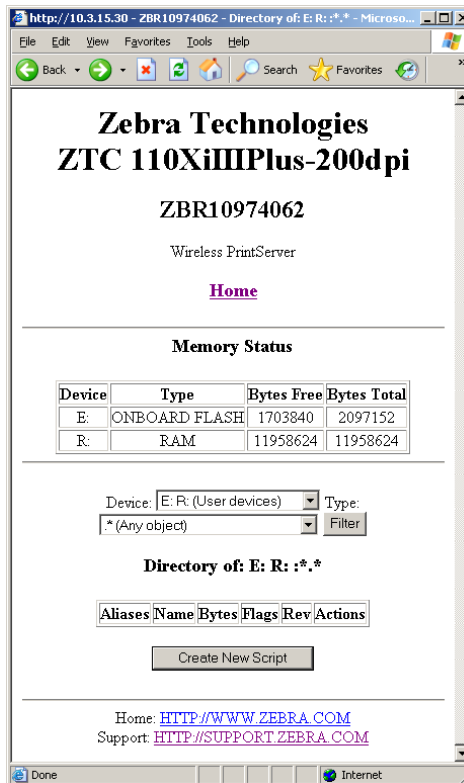

- From the Directory Listing screen, click **Create New Script**.
The Create New Script screen displays.

Figure 25 • Create New Script

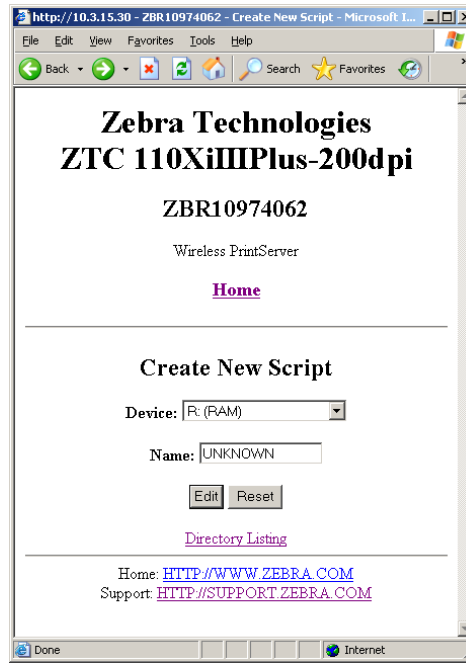

- Select a device type from the drop-down menu to indicate a memory location that is appropriate to your needs.
 - E: (ONBOARD FLASH)**—non-volatile memory, which is persistent across a power cycle.
 - R: (RAM)**—volatile memory, which is not persistent across a power cycle.
 - Z: (PRINTER INTERNAL MEMORY)**—non-volatile memory where the printer's internal bar codes and fonts are stored. You can print a list of the bar codes and fonts through the printer's control panel. Refer to the User Guide for your printer for instructions on listing the fonts and bar codes.
- Type a name for the file in the Name field.

5. Click **Edit**.

The Edit ZPL Script screen displays.

Figure 26 • Edit ZPL Script

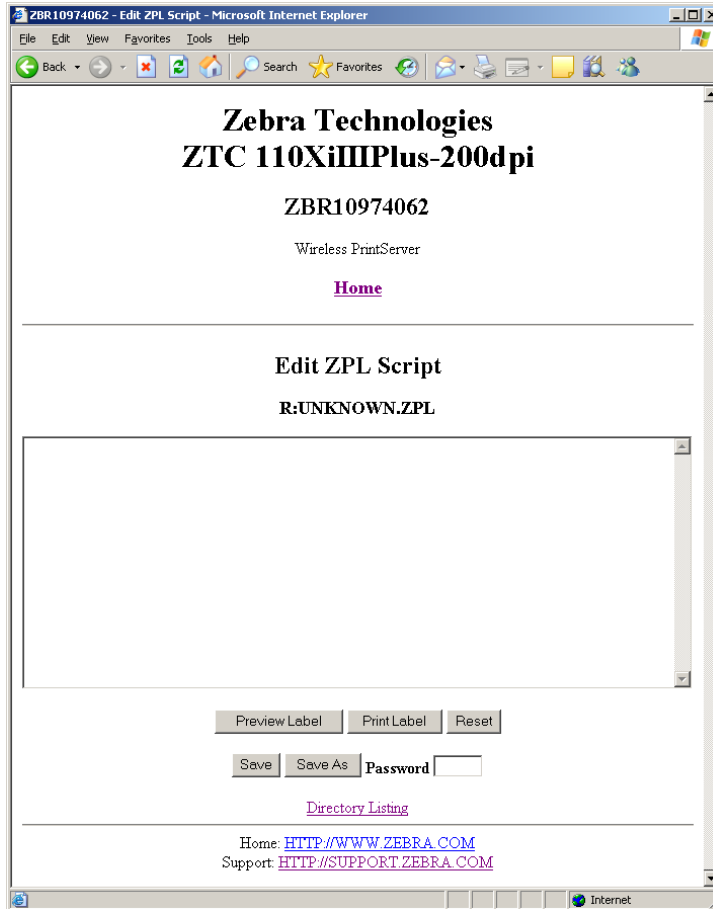

6. Enter the ZPL code in the text field.

7. Click one of the available buttons:

Button	Function/Operation
Preview Label	Displays a graphic representation of the label that results from the ZPL code.
Print Label	Sends the ZPL code to the printer.
Reset	Clears the text field.

Button	Function/Operation
Save	<p>a. Enter the printer password in the password field.</p> <p>b. Click Save.</p> <p>If the correct password was entered, saves the label to the ZPL file name entered on the Create New Script screen.</p>
Save As	<p>a. Enter the printer password in the password field.</p> <p>b. Click Save As.</p> <p>The Save ZPL Script screen displays.</p> <div data-bbox="802 560 1268 1199" data-label="Image"> </div> <p>c. Enter a file name in the Name field.</p> <p>d. Click Save.</p> <p>If the correct password was entered on the Edit ZPL Script screen, the file is saved.</p>

Printer Controls

This page offers control over basic printer functions.

Other functions are also accessible from this page. These include:

- Feed — causes printer to feed one label.
- Cancel One Format — cancels the currently printing format.
- Cancel All Formats — cancels all formats.
- Reset Printer — causes printer to perform its standard reset without cycling power.

To view Printer Controls, complete these steps:

1. From the Printer Home Page, click Printer Controls.

This Printer Controls page opens.

Figure 27 • Printer Controls



Important • In this view, you must have administrative rights to make changes to the printer controls.

Print Server Web Pages

This section provides you with details on the print server features that were not covered in the chapter [Getting Started on page 39](#).

Contents

Print Server Features	110
Status and Configuration	110
Print Server Status	118
Reset	120
Restore	121

Print Server Features

This section covers features available for the print server *only*, not the printer's features. Some of the features you access in this section prompt you to enter the default user ID and password.



Important • For specific information on the default User ID and/or default password, see [Default User ID and Password on page 41](#).

Status and Configuration

The steps that follow are based on the navigation of a ZPL printer using firmware X.15 or above.



Important • You can upgrade your firmware by visiting our web site: <http://www.zebra.com/firmware>.

To access the print server settings, complete these steps:

1. Open a Web browser.
2. In the Address text-box, type your printer's IP address, and press Enter.
The Printer Home Page opens.

Figure 28 • Printer Home Page

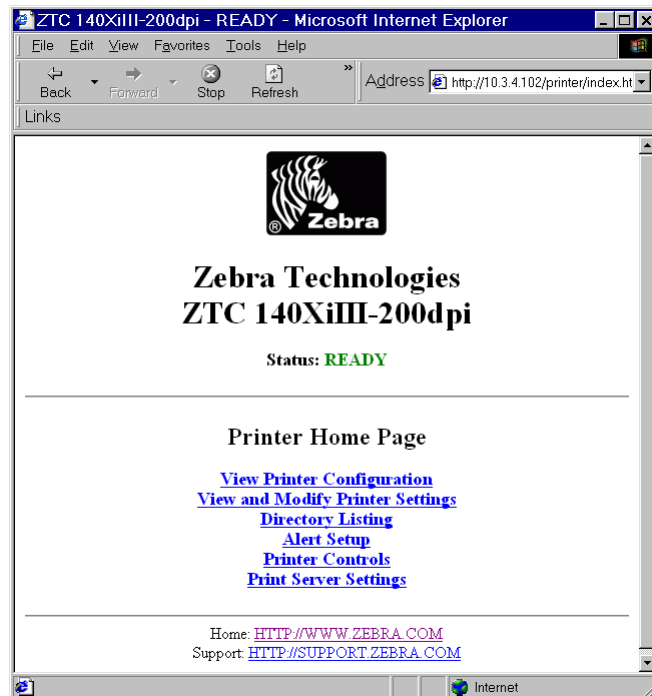

3. From the Printer Home Page, click Print Server Settings.
The Print Server Settings Page opens.

Figure 29 • Print Server Settings Page

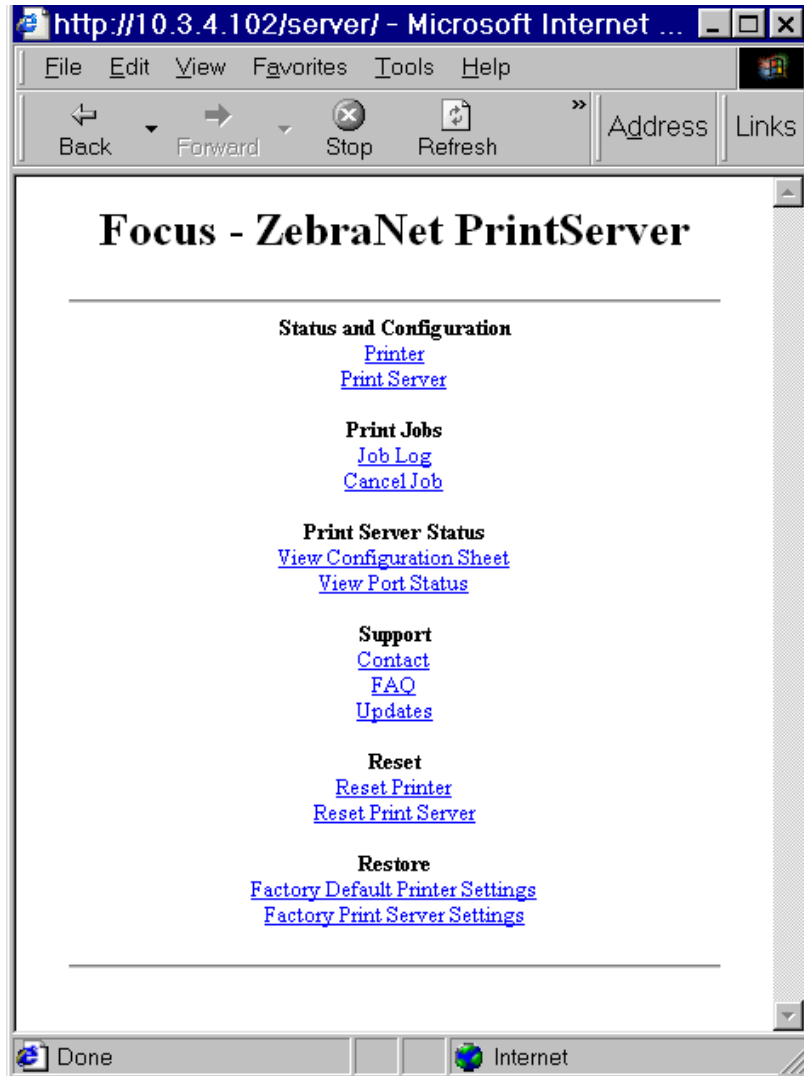

4. From the Print Server Settings Page, click Print Server.
The Print Server Configuration page opens.

Figure 30 • Print Server Configuration

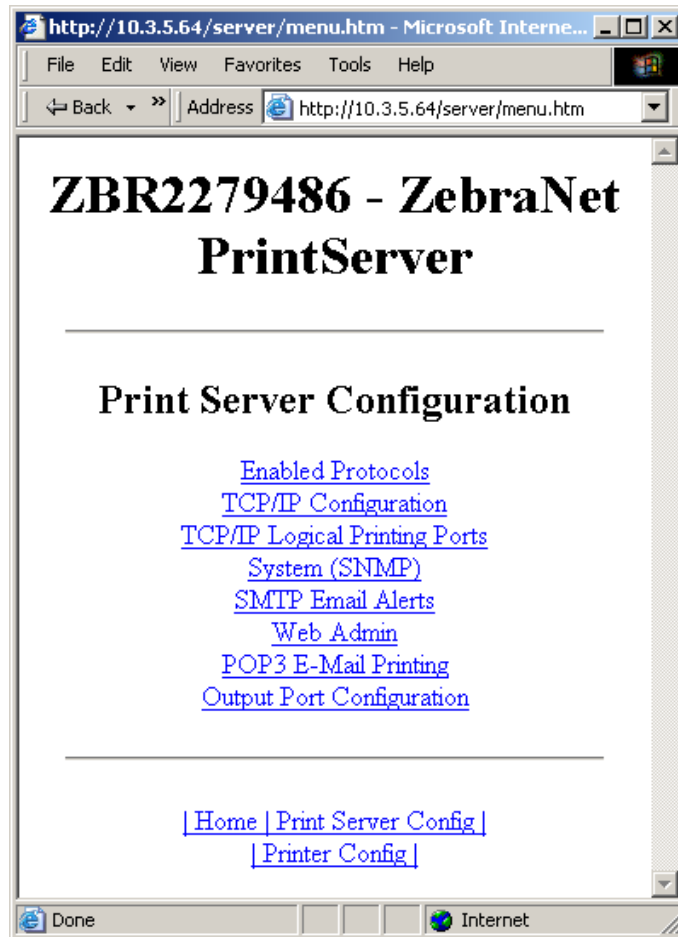

5. In the Print Server Configuration page, you have a menu from which to choose. [Table 19](#) identifies each menu option page.

Table 19 • Print Server Configuration Menu Options

Enabled Protocols

Modifies the protocols to be used: NetWare, HP JetAdmin, or both.

Enabling Hewlett-Packard's HP JetAdmin Support allows the status from the Zebra device to display in HP JetAdmin utility.

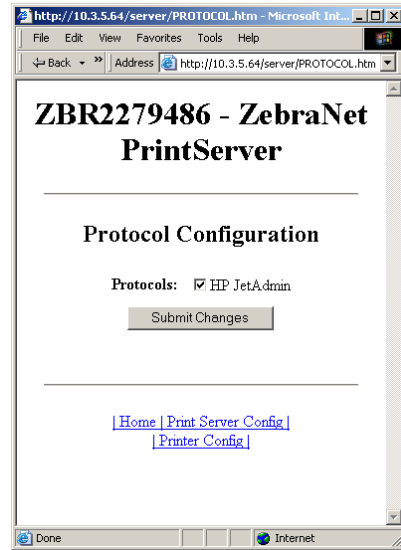

Table 19 • Print Server Configuration Menu Options (Continued)

TCP/IP Configuration

You can change the TCP/IP configuration of the 10/100 Internal Print Server.

- **IP Address:** Use this feature to set the IP address if using the Permanent addressing method.
- **IP Address Resolution:** Use this feature to select the addressing method to use (Dynamic or Permanent).
- **Dynamic Protocols:** Use this feature to select the Dynamic Addressing method to use at startup. Choices include RARP, BOOTP, DHCP, Gleaning or Default Address.
- **Subnet Mask:** Use this feature to set the subnet mask. The subnet mask must follow the format XXX.XXX.XXX.XXX, where each XXX is a number between 0 and 255.
- **Default Gateway:** Use this feature to set the default gateway. This gateway will be used whenever messages need to be sent to another network. This gateway address must follow the format XXX.XXX.XXX.XXX, where each XXX is a number between 0 and 255.
- **WINS Server IP Address:** Use this feature to set or view the IP address of the WINS Server.
- **Connection Timeout Checking:** Use this feature to enable or disable the Connection Timeout feature. The timeout is used to close network TCP/IP connections that are idle for more than the number of seconds entered in the Timeout Value.
- **Timeout Value (secs):** Use this feature to set the Connection Timeout Value. The Valid range is 10 to 3600 seconds. The default is 300 seconds.
- **ARP Broadcast Interval (mins):** Use this feature to set interval for sending an ARP Broadcast. The valid range is 1 to 30 minutes. Address Resolution Protocol (ARP) broadcast packets allow other network devices to associate the print server's IP Address with its hardware address.
- **Base Raw Port Number:** Use this feature to set the raw TCP port that the print server will use for printing tasks. The default is port 9100.

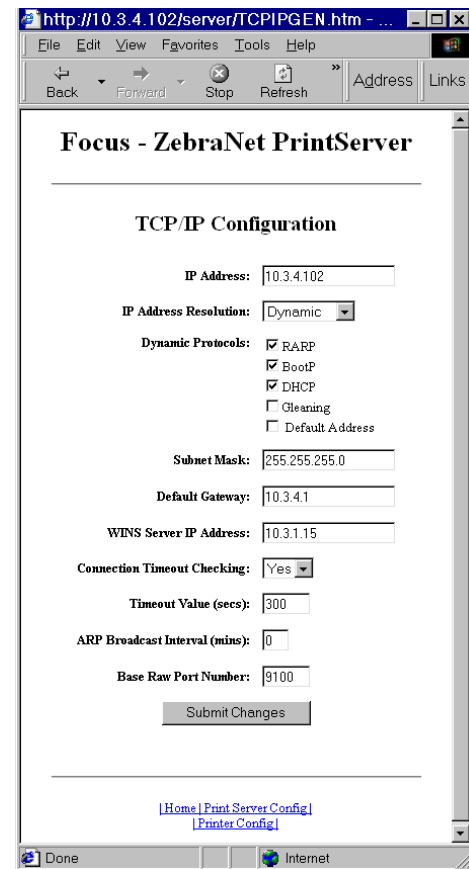
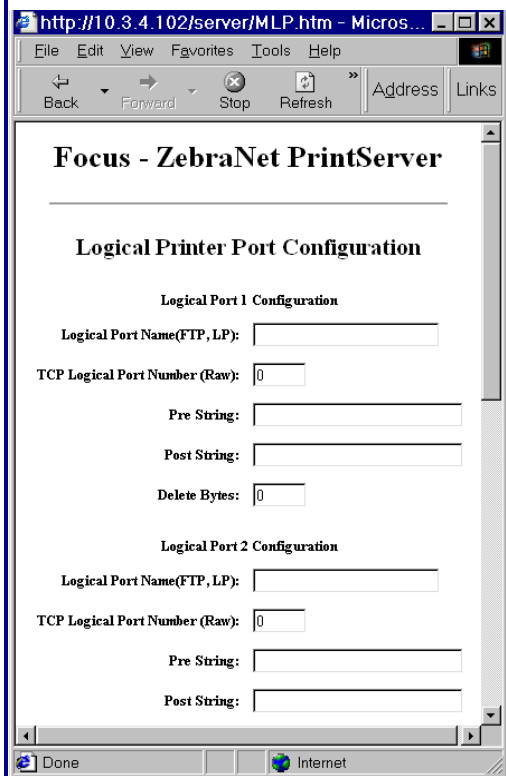

Table 19 • Print Server Configuration Menu Options (Continued)

TCP/IP Logical Printing Ports

Logical printers allow you to set up multiple pre- and post-processing configurations for each output port. Each logical port configuration can perform the following:

- Add user-configured strings before and after the print data.
- Remove unwanted characters from the beginning of the print data.
- Four logical printer configurations are supported for each output port on the printer. The configurations can be assigned to any port, and all of these configurations can be assigned to a single output port.



System (SNMP)

This feature gives you the ability to manage multiple devices on a network, be it printers, computers, or other network-attached devices. On this page, you can define the SNMP system name, system location (10/100 Internal Print Server description), and other SNMP settings for your 10/100 Internal Print Server.

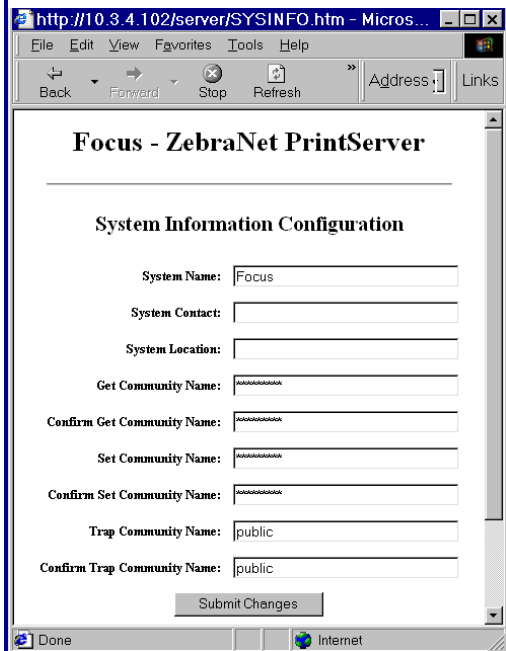
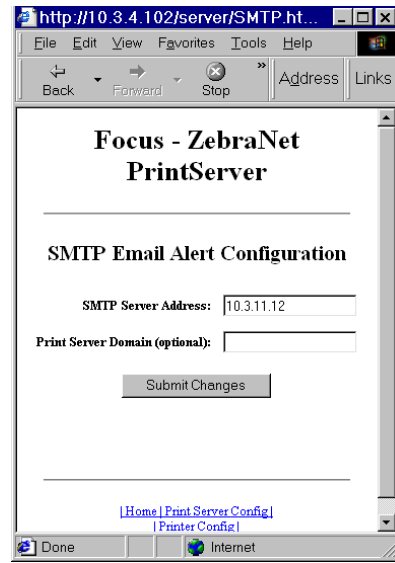

Table 19 • Print Server Configuration Menu Options (Continued)

SMTP Email Alert Configuration

This feature allows you to enter data regarding System Information on the network that is being used. Typically, a Network Administrator would use this.



Web Admin

This page allows you to configure the Admin name and password. Links to upgrades and support information can also be altered.

Note • The printer and print server password can be changed on ZPL printers with firmware x.10 or higher.

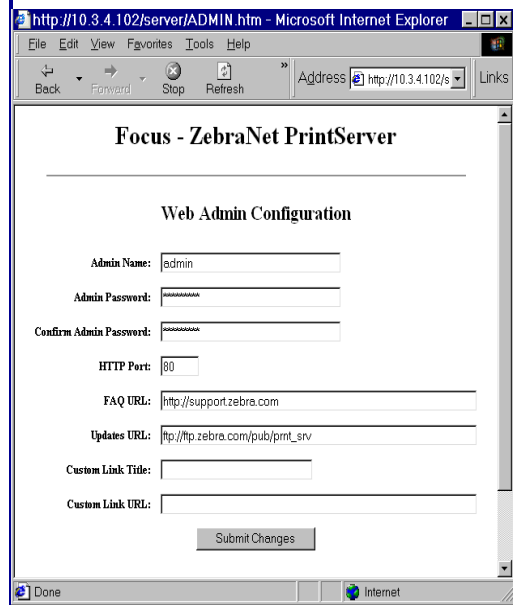
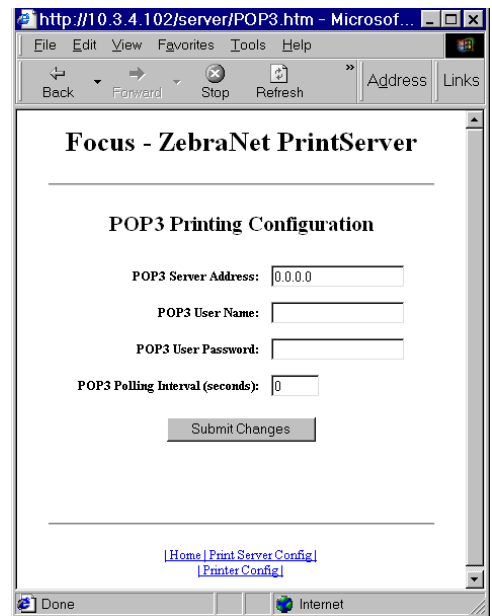

Table 19 • Print Server Configuration Menu Options (Continued)

POP3 Email Printing

This feature helps you set up the print server to receive email messages containing formats that can be printed. The POP3 settings must be set to retrieve emails from the email server.

Important • Zebra recommends setting the POP3 polling interval no lower than 30. Some email servers will lock accounts after repeated login attempts.



Output Port Configuration

This feature allows you to change the Parallel Port Mode setting.

Selections for Parallel Port Mode include Compatibility, Nibble, Byte, and ECP.

- Compatibility is a unidirectional forward mode used only for sending data to the printer.
- Nibble, Byte, and ECP modes are all bidirectional modes. Data can be sent to and from the printer.
 - Nibble mode sends only 4 bits of data at a time in the reverse direction from the printer to the print server. When in nibble mode, communications from the print server to the printer are accomplished via compatibility mode.
 - Byte mode sends a full byte of data at a time in the reverse direction from the printer to the print server. When in byte mode, communications from the print server to the printer are accomplished via compatibility mode.
 - ECP mode is a complete forward and reverse mode that more efficiently transfers data.

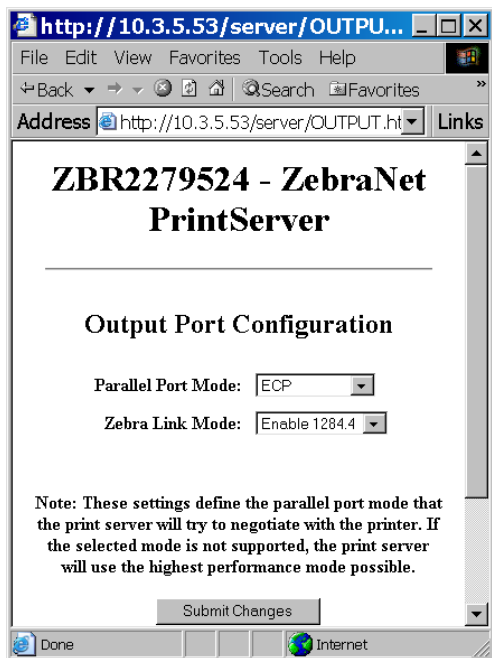

Print Server Status

From the Print Server page in the Print Server Status section, you can access the print server configuration page and port status.

To open the print server configuration page, complete this step:

1. From the PrintServer page, click View Configuration Page.
The Configuration Page opens.

Figure 31 • Configuration Sheet

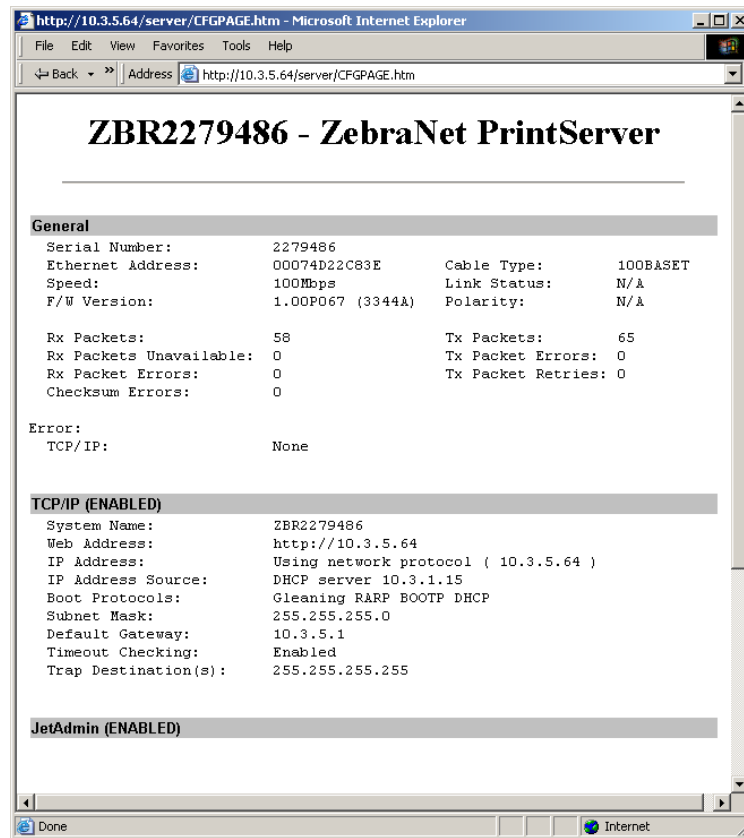



To view the port status complete this step:

The default User ID and password are required to access this page.



Important • For specific information on the default User ID and/or default password, see *Default User ID and Password* on page 41.

1. From the Print Server page, click View Port Status.
 The Port Status page opens.

Figure 32 • Port Status

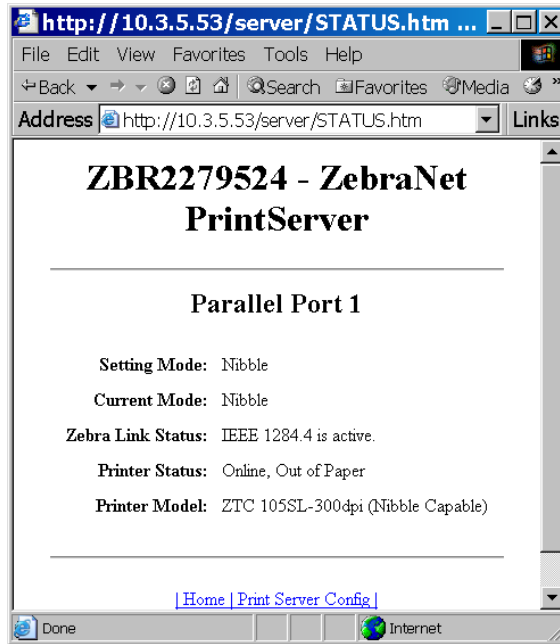

Reset

From the Print Server page in the Reset section, you can reset the print server configuration settings to what they were before you made the most recent changes.

To reset the print server, complete these steps:

1. From the Print Server page, click Reset Print Server.
The Reset Device page opens.

Figure 33 • Reset Print Server

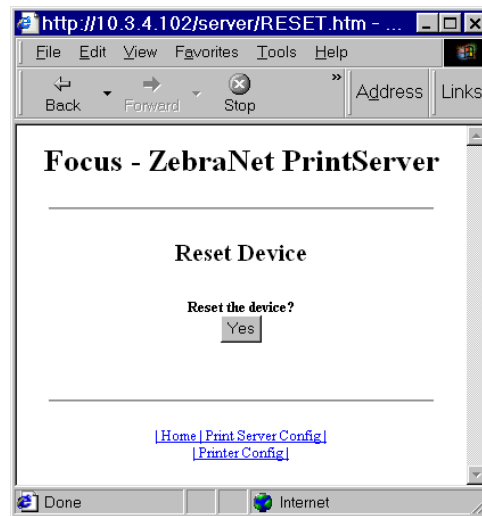

2. To reset print server, click Yes.

Restore

From the Print Server page, in the Restore section you can restore the print server to the default factory settings.

To restore print server to the default factory settings, complete these steps:

1. From the Print Server page, click Factory Print Server Settings.
 The Restore To Factory Defaults page opens.

Figure 34 • Restore to Factory Settings

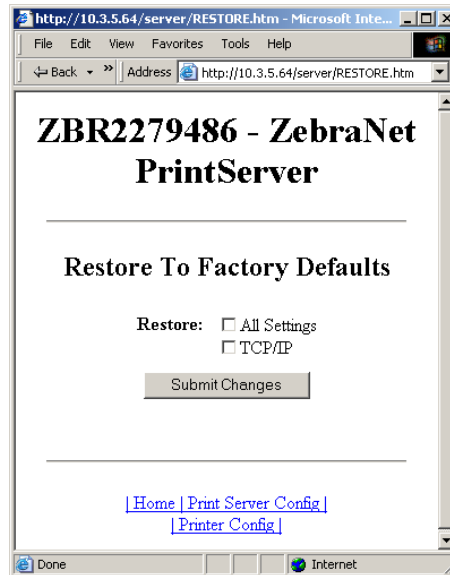

2. Make the selections you want, and click Submit Changes



Notes •

Control Panel

This section provides you with details on the Control Panel menu options.

Contents

Control Panel Menu Options	124
Wired Network Parameters on the LCD	124
Wireless Network Parameters on the LCD	126

Control Panel Menu Options

Control Panel (or Liquid Crystal Display—LCD) menu options only appear if a print server is installed. The control panel parameters are somewhat different for different printers. Refer to the user guide for your printer for specific instructions on how to modify the control panel parameters.



Note • The ZT210 and ZT220 printers have the same parameters available, but do not have control panels. Refer to the Zebra ZT210/ZT220/ZT230 User Guide for more information on how to access these parameters.

Wired Network Parameters on the LCD

Table 20 identifies the wired network parameters available on your Zebra *XiIIIPlus*, Z4Mplus/Z6Mplus, 105SL, PAX4, Xi4, ZM400/ZM600, S4M, ZE500, and ZT230 printers/print engines with a print server installed.

Table 20 • Wired Network Parameters









<i>XiIIIPlus</i>	Z4Mplus/Z6Mplus	105SL	PAX4	Xi4	ZM400/ZM600	S4M	ZE500	ZT230	LCD Option	Details
				✓	✓		✓		LIST NETWORK	Prints a network configuration label.
✓	✓	✓	✓						WIRED PS CHECK?	This tells if the printer searches for a wired print server at bootup.
				✓	✓		✓	✓	 PRIMARY NETWORK The ZT230 LCD menu will appear as: PRIMARY PRINT SERVER	This allows you to see if the printer is using an IP setting from the wireless or a wired print server at bootup.
✓	✓	✓	✓	✓	✓		✓		 LOAD LAN FROM? The Xi4 and the ZM400/ZM600 LCD menu will appear as: LOAD FROM EXT?	This determines if the printer uses IP settings from the printer or the print server at bootup.
✓	✓	✓	✓	✓	✓		✓	✓	ACTIVE PRINTSRVR	This allows you to see which print server is being used.

Table 20 • Wired Network Parameters

XIIIPlus	Z4Mplus/Z6Mplus	105SL	PAX4	Xi4	ZM400/ZM600	S4M	ZE500	ZT230	LCD Option	Details
✓	✓	✓	✓	✓	✓	✓	✓	✓	IP PROTOCOL  The S4M LCD menu will appear as: OBTAIN IP ADDRESS followed by: CHANGE IP PROTOCOL	The allows you to see if the user (permanent) or the server (dynamic) selects the IP address.
✓	✓	✓	✓	✓	✓	✓	✓	✓	IP ADDRESS  The S4M LCD menu will appear as: CHANGE IP ADDRESS	This allows you to modify this setting, only when Permanent is select for OBTAIN IP ADDRESS.
✓	✓	✓	✓	✓	✓	✓	✓	✓	SUBNET MASK  The S4M LCD menu will appear as: CHANGE SUBNET	This allows you to view the subnet mask.
✓	✓	✓	✓	✓	✓	✓	✓	✓	DEFAULT GATEWAY  The S4M LCD menu will appear as: CHANGE GATEWAY  The ZT230 LCD menu will appear as: GATEWAY	This allows you to view the default gateway.
✓	✓	✓	✓	✓	✓	✓	✓	✓	MAC ADDRESS	This allows you to view the MAC address for the current wireless radio card.
✓	✓	✓	✓	✓	✓	✓	✓	✓	RESET NETWORK  The ZT230 LCD menu will appear as: LOAD DEFAULTS	This allows you to re-initialize the wireless radio card and the print server (wired or wireless).

Wireless Network Parameters on the LCD

Table 21 identifies the wireless network parameters available on your Zebra *XiIIIPlus*, Z4Mplus/Z6Mplus, 105SL, PAX4, Xi4, ZM400/ZM600, ZE500, and ZT230 printers/print engines with a print server installed.



Note • The ZT210 and ZT220 printers have the same parameters available, but do not have control panels. Refer to the Zebra ZT210/ZT220/ZT230 User Guide for more information on how to access these parameters.

Table 21 • Wireless Network Parameters









<i>XiIIIPlus</i>	Z4Mplus/Z6Mplus	105SL	PAX4	Xi4, R110Xi4	ZM400/ZM600, RZ400/600	S4M	ZE500	ZT230	LCD Option	Details
✓	✓	✓	✓				✓		WIRED PS CHECK?	This tells if the printer searches for a wired print server at bootup.
				✓	✓			✓	 PRIMARY NETWORK The ZT230 LCD menu will appear as: PRIMARY PRINT SERVER	This allows you to see if the printer is using an IP setting from the wireless or a wired print server at bootup.
✓	✓	✓	✓	✓	✓		✓		 LOAD LAN FROM? The Xi4 and the ZM400/ZM600 LCD menu will appear as: LOAD FROM EXT?	This determines if the printer uses IP settings from the printer or the print server at bootup.
				✓	✓		✓	✓	ACTIVE PRINTSRVR	This allows you to see which print server is being used.
✓	✓	✓	✓	✓	✓		✓	✓	IP PROTOCOL  The S4M LCD menu will appear as: OBTAIN IP ADDRESS followed by: CHANGE IP PROTOCOL	The allows you to see if the user (permanent) or the server (dynamic) selects the IP address.

Table 21 • Wireless Network Parameters

X111Plus	Z4Mplus/Z6Mplus	105SL	PAX4	Xi4, R110Xi4	ZM400/ZM600, RZ400/600	S4M	ZE500	ZT230	LCD Option	Details
✓	✓	✓	✓	✓	✓	✓	✓	✓	IP ADDRESS  The S4M LCD menu will appear as: CHANGE IP ADDRESS	This allows you to modify this setting, only when Permanent is select for OBTAIN IP ADDRESS.
✓	✓	✓	✓	✓	✓	✓	✓	✓	SUBNET MASK  The S4M LCD menu will appear as: CHANGE SUBNET	This allows you to view the subnet mask.
✓	✓	✓	✓	✓	✓	✓	✓	✓	DEFAULT GATEWAY  The S4M LCD menu will appear as: CHANGE GATEWAY  The ZT230 LCD menu will appear as: GATEWAY	This allows you to view the default gateway.
✓	✓	✓	✓	✓	✓	✓	✓	✓	MAC ADDRESS	This allows you to view the MAC address for the current wireless radio card.
✓	✓	✓	✓	✓	✓	✓	✓	✓	RESET NETWORK  The ZT230 LCD menu will appear as: LOAD DEFAULTS	This allows you to re-initialize the wireless radio card and the print server (wired or wireless).
✓	✓	✓	✓	✓	✓	✓	✓		ESSID	This allows you to view the ESSID value for your wireless network.
✓	✓	✓	✓	✓	✓	✓	✓		WLAN SECURITY	This allows you to view the WLAN Security Type.



Notes • _____

Hardware Troubleshooting

This section provides you with solutions to known issues.

Contents

Troubleshooting the External 10/100 Print Server	130
Resetting to Factory Defaults	130
External ZebraNet 10/100 Print Server Network Status and Status Indicators	130
Troubleshooting the External ZebraNet 10/100 Print Server	131
Troubleshooting the Internal ZebraNet 10/100 Print Server	133
Resetting the Internal ZebraNet 10/100 Print Server to Factory Defaults	133
Internal ZebraNet 10/100 Print Server Network Status and Activity Indicators	133
Troubleshooting the Wireless Print Server	135
Resetting the Wireless Print Server to Factory Defaults	135
ZebraNet Bridge Discovery or Configuration Problems	136
Unable to Print	136
Ping the Printer	136
Telnet	137
Unable to Configure Device	138
HP JetAdmin or HP Web JetAdmin	138
Wireless Error Messages	138
General Wireless Issues	139
Encryption and Authentication Issues	141
IP Issues	142



Troubleshooting the External 10/100 Print Server

Resetting to Factory Defaults



Note • You must have an active network cable connected to the external ZebraNet 10/100 Print Server device to default the device using the Test button.

See *Defaulting the ZebraNet 10/100 Print Server on the 105SL, S4M, PAX4 and External Devices* on page 74.

External ZebraNet 10/100 Print Server Network Status and Status Indicators

Alongside of the RJ45 connector, there are two LED's containing a red element and a green element. By turning on and off different combinations of these two LED elements, the LED indicates Ethernet links, activity, and speed. For indicator locations, see [Figure 3, External ZebraNet 10/100 Print Server](#), on page 33.

Network Status LED State	Description
Off	No Ethernet link detected
Amber	10 Mbps link detected
Amber, blinking	10 Mbps link detected and Ethernet activity detected
Green	100 Mbps link detected
Green, blinking	100 Mbps link detected and Ethernet activity detected

Status LED State	Description
Green, solid	Print server is working.
Green, flashing	For solutions, see Table 22 on page 131 .
Red, solid	For solutions, see Table 22 on page 131 .
Red, flashing	For solutions, see Table 22 on page 131 .
Alternating Red/Green	For solutions, see Table 22 on page 131 .

Troubleshooting the External ZebraNet 10/100 Print Server

Table 22 • External ZebraNet 10/100 Print Server Issues and Solutions

Issue	Possible Cause	Recommended Solution
The Status LED is slowly flashing red	The external ZebraNet 10/100 Print Server has not detected the presence of a network cable.	<ol style="list-style-type: none"> 1. Turn the printer off (O). 2. Remove the network cable from the external ZebraNet 10/100 Print Server. 3. Plug the network cable back in until you hear a click. 4. Check the other end of the cable in the same manner. 5. Turn the printer on (I).
	A bad or wrong cable.  Important • Cables with a rating higher than CAT-6 have not been tested.	<ol style="list-style-type: none"> 1. Verify that the network cable is appropriate for the network and has an RJ-45 connector. 2. Connect the external ZebraNet 10/100 Print Server to a network drop that is a known good network connection. 3. If the external ZebraNet 10/100 Print Server is still unable to detect the network cable, contact Technical Support for assistance.
	Power On Self-Test (POST) is in progress.	Wait for the printer to complete the POST.
The Status LED is slowly flashing green (1 time/sec)	The external ZebraNet 10/100 Print Server is trying to print a job.	If the job does not print, check the following: <ol style="list-style-type: none"> 1. Verify that the printer has media and ribbon (if in thermal transfer mode). 2. If the printer is showing any errors, the external ZebraNet 10/100 Print Server cannot send data to the printer. The LED continues to blink until the printer malfunction is resolved or until the printer is turned off (O).

Table 22 • External ZebraNet 10/100 Print Server Issues and Solutions (Continued)

Issue	Possible Cause	Recommended Solution
<p>The Status LED is solid red for more than 30 seconds</p>	<p>The external ZebraNet 10/100 Print Server has failed the POST.</p>	<p>If the failure is not severe, the external ZebraNet 10/100 Print Server attempts to print a configuration label on the printer.</p> <ol style="list-style-type: none"> 1. Turn the printer off (O), wait 10 seconds, then turn the printer on (I). 2. If the external ZebraNet 10/100 Print Server still fails the POST, the print server has a hardware problem that can only be fixed by replacing or returning the unit. 3. Contact Repair for repair or replacement information.
	<p>A failed POST may be a connection to a malfunctioning external ZebraNet 10/100 Print Server device.</p>	
<p>The Status LED is alternately flashing red and green for longer than 2 minutes</p>	<p>The external ZebraNet 10/100 Print Server is in firmware-download mode. This means it is waiting for new firmware data to be sent before it continues normal functioning.</p>	<ul style="list-style-type: none"> • If the external ZebraNet 10/100 Print Server was purposely put into firmware-download mode, finish the download with the proper update utility. Visit the Zebra Web site at http://www.zebra.com/utilities to download this utility. • If the external ZebraNet 10/100 Print Server was not put into firmware-download mode or if you wish to exit this mode, default the unit. Follow the instructions in <i>Defaulting the ZebraNet 10/100 Print Server on the 105SL, S4M, PAX4 and External Devices</i> on page 74.



Troubleshooting the Internal ZebraNet 10/100 Print Server

Resetting the Internal ZebraNet 10/100 Print Server to Factory Defaults

Which model printer do you have?

If you have a...	Then...
ZM400 or ZM600 printer	Go to <i>Defaulting the Print Servers on the ZM400 and ZM600 Printers</i> on page 75.
G-Series, ZP Series, or LP/TLP 2824 Plus printer	Go to <i>Defaulting the Print Servers on the ZP Series, LP/TLP 2824 Plus, and G-Series Printers</i> on page 75.
HC100 printer	Go to <i>Defaulting the Print Servers on the HC100 Printers</i> on page 76.
105SL, PAX4, Xi4, and ZE500 printer/print engine	Go to <i>Defaulting the Print Servers on the 105SL, PAX4, Xi4, and ZE500 Printers</i> on page 76.
ZT210 and ZT220 printer	Go to <i>Defaulting the Print Servers on the ZT210 and ZT220 Printers</i> on page 77.
ZT230 printer	Go to <i>Defaulting the Print Servers on the ZT230 Printers</i> on page 77.

Internal ZebraNet 10/100 Print Server Network Status and Activity Indicators

For the S4M, 105SL, and PAX4 Printers/Print Engines

Alongside of the RJ45 connector, there are two LED's containing a red element and a green element. By turning on and off different combinations of these two LED elements, the LED indicates Ethernet links, activity, and speed.

Network Status LED State	Description
Off	No Ethernet link detected
Amber	10 Mbps link detected
Amber, blinking	10 Mbps link detected and Ethernet activity detected
Green	100 Mbps link detected
Green, blinking	100 Mbps link detected and Ethernet activity detected

Status LED State	Description
Green, solid	Print server is working.
Green, flashing	For solutions, see Table 22 on page 131 .
Red, solid	For solutions, see Table 22 on page 131 .
Red, flashing	For solutions, see Table 22 on page 131 .
Alternating Red/Green	For solutions, see Table 22 on page 131 .

For the ZM400, ZM600, HC100, and Xi4 Printers

Alongside of the RJ45 connector, there is a single LED containing a red element and a green element. By turning on and off different combinations of these two LED elements, the LED indicates Ethernet links, activity, and speed.

LED State	Description
Off	No Ethernet link detected
Amber	10 Mbps link detected
Amber, blinking	10 Mbps link detected and Ethernet activity detected
Green	100 Mbps link detected
Green, blinking	100 Mbps link detected and Ethernet activity detected

For the G-Series, ZP Series, and LP/TLP 2824 Plus Printers

On the top of the RJ45 connector, two LEDs are provided for these printers. The left LED is green and the right LED is amber. Follow the table below to determine activity and status of the G-Series, ZP Series, and LP/TLP 2824 Plus printers.

Left LED State	Right LED State	Description
Off	Off	No Ethernet link detected
Off	Amber	10 Mbps link detected
Green, blinking	Amber	10 Mbps link detected and Ethernet activity detected
Green	Off	100 Mbps link detected
Green	Amber, blinking	100 Mbps link detected and Ethernet activity detected



Troubleshooting the Wireless Print Server

ZebraNet n Print Server Will Not Operate on the 5Ghz Band

You may need to set your country code in order to enable the 5Ghz band for the ZebraNet n Print Server.

- If you are using the wireless print server in the United States, Canada, or Japan, you will not need to set the country code. These countries have been pre-set at the factory.
- If you are operating the print server anywhere else in the world, you must set the country code to enable the 5GHz band. To set the country code, you must send a Set-Get-Do command to the printer. For specific command information, see the *Programming Guide for ZPL II, ZBI 2, Set-Get-Do, Mirror and WML*.

Resetting the Wireless Print Server to Factory Defaults

You may need to restore the network parameters to the factory defaults under the following circumstances:

- If you download a different version of firmware to your printer
- If you need to reset the encryption keys (for instances where a key was entered incorrectly or was forgotten)

After you return the network parameters to the defaults, you must reconfigure your printer to use the wireless print server (see [Configuration of Wireless Securities on page 49](#)). If you saved the ZPL script generated by the Wireless Setup Wizard, simply send this file to the printer, and then power cycle the printer. If you were using a wireless password, you must set it again (use the `^WP` ZPL command or the `wlan.password SGD` command).

You can set the network parameters back to the factory defaults in two ways:

- The **Restore Default Network Configuration** button on the printer's View and Modify Printer Settings Page (see [Figure 34 on page 121](#)).
- The **DEFAULT NET** option, which appears as an option when you exit Setup mode. Refer to the User Guide for your printer for specific instructions on how to modify the control panel parameters.



Note • The **LOAD DEFAULTS** option and the **Restore Default Configuration** button reset all printer parameters other than network settings back to factory defaults. The network settings will not change when these options are selected.

ZebraNet Bridge Discovery or Configuration Problems

If you are having problems using ZebraNet Bridge to discover or configure the unit, check the following:

- Verify there is not a router between the workstation running ZebraNet Bridge and the print server. Because the print server does not have an IP address, TCP/IP communication cannot be started across a router. Run ZebraNet Bridge on the same subnet as the print server.
- Verify the wired print server has a solid green light. If the LED shows a rapidly flashing green light, check the network cable that is attached.
- Verify the wireless print server has authenticated to the access point. See *LCD Link Status and Wireless Signal Indicators* on page 50 for more detailed information.

Unable to Print

If you are having problems printing, verify that there is communication between the print server and the printer. Check the following:



- For the external ZebraNet 10/100 Print Server, print a configuration label by pressing the test button. If a configuration label does not print, verify the printer has media and ribbon (if used) and is not paused.
- For all print servers:
 - Ping the printer to determine the ability to communicate with the printer. See *Ping the Printer*.
 - Or open a Telnet session and send a ZPL command to print a configuration label. See *Telnet* on page 137 for more information.
 - Check obvious error conditions such as head open, out of media, out of ribbon, etc.
 - If problems persist, contact Technical Support.

Ping the Printer

To ping the printer, complete these steps:

1. Open a DOS window.
To open a DOS window, click on **Start > Run**.
2. In the Open text box, type: `cmd`
3. From the DOS prompt, type:
`ping xxx.xxx.xxx.xxx`
where `xxx.xxx.xxx.xxx` is the IP address of the print server

- See [Figure 35](#). You see a reply from the print server indicating a connection.

Figure 35 • Example of a Successful Ping

```
C:\>ping 172.30.1.34

Pinging 172.30.1.34 with 32 bytes of data:

Reply from 172.30.1.34: bytes=32 time=8ms TTL=126
Reply from 172.30.1.34: bytes=32 time=25ms TTL=127
Reply from 172.30.1.34: bytes=32 time=6ms TTL=127
Reply from 172.30.1.34: bytes=32 time=23ms TTL=127

Ping statistics for 172.30.1.34:
    Packets: Sent = 4, Received = 4, Lost = 0 (0% loss),
    Approximate round trip times in milli-seconds:
        Minimum = 6ms, Maximum = 25ms, Average = 15ms
```

If the issue is a communication problem, you would have received an error message.

Telnet

Open a telnet session to send a ZPL command from a DOS prompt.



Note • You do not need to open a telnet session if you pinged the printer using the previous procedure. The purpose of these two procedures is to identify whether your PC can communicate with your printer.

To print a configuration label by sending a ZPL II command, complete these steps:

- Open a DOS window.
To open a DOS window, click on Start > Run.
- In the Open text box, type: cmd
- From the DOS prompt, type:
telnet xxx.xxx.xxx.xxx 9100
where xxx.xxx.xxx.xxx is the IP address of the print server.
This will connect your PC to the print server through the parallel port of the printer.
- Enter ~WC.
This ZPL command will print a configuration label on your printer.
- Click the **X** in the upper right-hand corner of the window to exit.

If the configuration label prints, the issue is not a communication problem between the printer, the print server, or the PC.

Unable to Configure Device

To assign an IP address to a ZebraNet print server using ZebraNet Bridge, you must be on the same subnet. If ZebraNet Bridge has Multicast enabled, you may be able to view the ZebraNet print server on another subnet, but you will not be able to configure the device.

HP JetAdmin or HP Web JetAdmin

The ZebraNet print server may be set up and managed using HP JetAdmin or HP Web JetAdmin products.



Wireless Error Messages

Table 23 shows error messages that may appear on the control panel.

Table 23 • Error Messages

Message	Description
NO CARD INSERTED	The wireless radio card is not inserted at all or is not fully seated.
NOT ASSOCIATED	The wireless radio card is present but cannot log on to the network.
NOT AUTHENTICATED	The wireless radio card is present and associated with the access point, but it has not been authenticated by the authentication server.
RADIO WARNING POOR SIGNAL	The wireless signal strength has dropped below the poor signal threshold value, which is set through the Wireless Setup web page (see <i>Wireless Setup</i> on page 102).  Note • The poor signal setting affects when you see the POOR SIGNAL warning, but it does not affect whether your printer will be able to associate with your network at a low signal strength.



General Wireless Issues

Table 24 • General Issues and Recommended Solutions

Issue	Possible Cause	Recommended Solution
The printer acknowledges the wireless radio card and indicates a signal strength, but the printer does not appear to connect to the network.	The combination of signal strength and signal quality at the printer may not be good enough to establish a connection to the network.	Move the printer or the access point to another location, or remove any obstructions between the two. A direct line of site between the printer and access point provides the best results. Refer to the third-party documentation for your access point for additional recommendations and limitations.
	The printer is associated with, but not authenticated with, your access point.	<ol style="list-style-type: none"> 1. Check your encryption settings. 2. Verify that your MAC address is approved for the access point.
The printer does not acknowledge the wireless radio card.	The card may not be inserted correctly.	Make sure that the wireless radio card is correctly seated in the wireless option card slot.
	Your printer may not be equipped with a ZebraNet wireless print server.	Contact your authorized Zebra representative for information about purchasing a ZebraNet wireless print server.
	The card may not be supported for use with the ZebraNet wireless print servers.	Make sure that you are using a compatible wireless radio card (see <i>Supported Wireless Radio Cards</i> on page 17).
After a firmware upgrade, the printer will not connect to the network.	Network settings need to be updated.	<ol style="list-style-type: none"> 1. Reset the printer's network settings to their defaults. Refer to <i>Defaulting ALL Print Servers</i> on page 73. 2. Reconfigure your printer to use the ZebraNet wireless print server (see <i>Configuration of Wireless Securities</i> on page 49). If you saved the ZPL script generated by the ZebraNet Bridge Wireless Setup Wizard utility, simply send this file to the printer. If you were using a wireless password, you need to set it again (use the ^WP ZPL command or the wlan.password SGD command). 3. Power cycle the printer for the settings to take effect.

Table 24 • General Issues and Recommended Solutions (Continued)

Issue	Possible Cause	Recommended Solution
My wireless connection is inconsistent. The signal strengths change back and forth between high and low numbers.	An access point may be bad. The card appears to be switching affiliations between access points.	Check the access points on your WLAN, particularly the one closest to the printer.
	The wireless radio card is repeatedly associating with two or more access points because of varying signal strengths.	Check the access points on your WLAN to determine what is causing the signal strengths to vary.
My “n” Print Server is not operating on the 5Ghz band.	You have not set the region code and are located in a country other than: <ul style="list-style-type: none"> • United States • Canada • Japan 	If you are operating outside of the three countries listed, you must send a specific Set-Get-Do command to set your country code. For specific command information, see the <i>Programming Guide for ZPL II, ZBI 2, Set-Get-Do, Mirror, and WML</i> .



Encryption and Authentication Issues

Table 25 • Encryption and Authentication Issues and Recommended Solutions

Issue	Possible Cause	Recommended Solution
The entry field for WEP keys on the printer's web page does not display all 26 characters.	The field accepts 26 characters, but they may not be able to display all at once because of your browser or system settings.	Use the left and right arrow keys on your keyboard to move the cursor in the WEP key field and reveal characters that may not display.
I set WEP encryption keys using the ^WX ZPL command, and now my wireless print server does not function.	The ZPL script that you sent to the printer may have been incorrect. The printer may be using the wrong encryption key or looking for one that is undefined.	Resend the ^WX command. Make sure that all of the required commas are in place in the command. A missing or extra comma in this command can prevent the printer from joining the wireless network.
I set WEP encryption keys using the ^WE ZPL command, and now my wireless print server does not function.	The ZPL script that you sent to the printer may have been incorrect. The printer may be using the wrong encryption key or looking for one that is undefined.	Use the ^WX command instead of ^WE.
	You enabled WEP and WPA encryption modes at the same time.	Before enabling a new security type, disable any mode used previously. Use the ^WX command instead of ^WE to ensure that only one security type is enabled at a time.
I set WEP encryption keys using the wlan.wep.index Set/Get/Do command, and now my wireless print server does not function.	The command that you sent to the printer may have specified the index number for an encryption key that is undefined.	Resend the wlan.wep.index command with the index number for a defined encryption key.
WPA mode will not work.	The wireless radio card contains an outdated version of firmware.	Flash the latest firmware to the wireless radio card. Contact the card manufacturer for details.
Kerberos mode will not work.	You are using a wireless radio card that does not support Kerberos. Kerberos is available only with Symbol Technologies Spectrum24 wireless radio cards.	Switch to a Symbol Technologies Spectrum24 wireless radio card.
The printer will not connect to the WLAN.	You are using a wireless radio card that does not support the security type being used on your WLAN.	Switch to a wireless radio card that supports your security type. Check Table 1 on page 19 , Table 2 on page 20 , or Table 3 on page 21 , for the security types supported by different wireless radio cards.

IP Issues

Table 26 • IP Issues and Recommended Solutions

Issue	Possible Cause	Recommended Solution
<p>The printer shows IP address 192.168.254.254, which does not appear to work.</p>	<p>IP address 192.168.254.254 is a default address. The printer shows this address after it times out while trying to connect. The printer was likely set to an incorrect static IP address.</p>	<p>Enter a valid static IP address. OR Set IP Protocol to All.</p>
	<p>The DHCP server is not functioning, so a dynamic IP address is not being assigned. The printer timed out and shows the default IP address of 192.168.254.254.</p>	<p>Check the DHCP server.</p>
<p>On my control panel, the IP settings are missing or show all zeroes (000.000.000.000).</p>	<p>Actual IP settings (IP Resolution, IP Address, Subnet Mask, and Default Gateway) will only appear when the printer is associated to and authenticated with the WLAN. Until the time that the printer recognizes the existence of a ZebraNet print server, these parameters will not show through the control panel. After the print server is recognized, all zeroes will display until the printer obtains an IP address or defaults to address 192.168.254.254.</p>	<ol style="list-style-type: none"> 1. Allow more time for the printer to complete its connection and obtain an IP address. 2. If the printer does not connect, check that there is an adequate signal between the printer and the access point. If necessary, move the printer or the access point to another location, or remove any obstructions between the two. A direct line of site between the printer and access point provides the best results. Refer to the third-party documentation for your access point for recommendations and limitations. 3. Check the IP Protocol setting. If using a static setting, the value entered might not be valid.
<p>The IP address for my wired print server does not bring up the printer home page.</p>	<p>If both a wired and wireless print server are installed on a printer at the same time and the wireless printer is the primary/active print server, the printer web pages can be accessed only through the wireless print server's IP address.</p>	<p>In your browser window, type in the IP address of the wireless print server.</p>

Frequently Asked Questions

This section provides a group of frequently asked questions (FAQs) about Zebra's wired and wireless print servers.

FAQs

Can the print server option work on a computer network that is running both TCP/IP and IPX protocols simultaneously? Yes. The print server runs all of its available protocols simultaneously. This means that the print server can run on mixed networks such as a network using Microsoft, and UNIX.



Important • The ZebraNet print servers do not support IPX, but they can function on networks that use protocols.

Will the ZebraNet print server allow connectivity to anything other than a PC network? Yes. The ZebraNet print server allows connectivity to systems such as IBM's AS400, provided that it is configured using TCP/IP. Other network protocols can be used with third-party adapters that are converted to 10BASE-T or 100BASE-T.

What if a print job makes it to the queue, but never leaves the queue? The label does not print. See [Table 27](#) for more information.

Table 27 • Things to Check

Issue	Possible Cause	Recommended Solution
If a print job makes it to the queue, but never leaves the queue?	Printer is not turned on	Confirm that the printer is turned on and receiving power.
	Printer is using a bad or wrong network cable.	Confirm that the network cable is plugged in and that you can ping the printer.
	There was a misconfiguration while creating the queue.	Verify the following: <ol style="list-style-type: none"> 1. Confirm that you use the print server's valid IP address. 2. If you are using a UNIX or AS/400 host, there is an option for the remote queue name. There is only one valid response to use: PORTLF1. 3. If Windows does not have an LPR installed, the above required option should be left blank. See the documentation for other operating system specific queue creation.

What are the minimum requirements to network a printer on a wired network?

- Cat-5 network cable with 10BASE-T or 100BASE-T connectors
- Internal or external print server
- Hub or Switch
- If a hub or switch is NOT used, you need a cross-over cable.
- Workstation running a TCP stack with print services installed.

What ports are open on any print server and related software?

TCP Ports:

- 21 FTP
- 23 Telnet
- 80 HTTP Server
- 515 Printer port
- 631 IPP port
- 9100 Raw socket connection



UDP Ports:

- 161 SNMP broadcast from print server
- 162 SNMP trap on ZebraNet Alert
- 4201 discovery destination on print server
- (dynamic) SNMP get request from ZebraNet Bridge
- (dynamic) discovery broadcast from ZebraNet Bridge
- (dynamic) discovery broadcast from ZebraNet Bridge

What is the default User ID and password for the print server?

- The User ID is **admin** and the password is **1234**.

What are my network connectivity options based on when using a print server?

It depends on your environment, but the print server accepts print jobs in any of the following ways:

- *FTP* — ZPL/EPL files can be sent to the printer via a FTP client as standard ASCII files.
- *HTTP* — (ZebraLink-enabled printers *only*) Using the script option of the print server's homepage, you can type ZPL into a specified location of the Web browser and send it to the printer.
- *IPP* — Using third-party IPP clients, print jobs can be sent via the Internet.
- *LPR/LPD* — Sometimes referred to as queue based printing. LPR/LPD is the standard in network printing. Most TCP/IP operating systems are compatible with this option.
- *Raw socket connection* — You can connect to the printer directly via the network, bypassing *everything in-between*. This option is commonly used to integrate ZPL/EPL into existing programs, such as VB scripts.
- *POP3* — With proper configuration, you can place ZPL/EPL files into the body of an email, and it will print. The print server periodically checks this email box at the specified intervals and prints the body of the message. **IMPORTANT:** Attachments and subject lines are not supported.



Glossary

10BASE-T A type of Ethernet that uses unshielded twisted pair cable.

100BASE-T A type of Ethernet that can transmit 100Mb of data per second with a twisted-pair cable.

ARP The standard TCP/IP method for determining the actual network address of a device based on its IP address.

ASCII A standard for the binary representation of characters.

BOOTP BOOTP (Bootstrap Protocol) is a protocol that lets a network user be automatically configured (receive an IP address) and have an operating system booted (initiated) without user involvement. The BootP server automatically configures the following information: IP address, gateway, subnet, system name, name server, and more from a pool of pre-determined addresses for a certain duration of time. BootP is the basis for a more advanced network manager protocol, the DHCP (Dynamic Host Configuration Protocol).

broadcast In a network, a situation when all destinations on the network receive a given packet.

client A workstation or PC in a client/server environment.

community For SNMP, a relationship between an agent and a set of SNMP managers that defines security characteristics. The community concept is a local one, defined at the agent. Each community is given a unique community name.

current mode (parallel port) A mode that the printer and print server negotiate.

DHCP (Dynamic Host Configuration Protocol) DHCP is an alternative to another network IP management protocol, Bootstrap Protocol (BOOTP). Like BOOTP, DHCP can configure an IP address, gateway, subnet, system name, and name server. When speaking about any print server, BOOTP, and DHCP configure the same options.

delete bytes This number is used to remove characters from the beginning of every job sent to the logical printer. The value for delete bytes can range from 0 to 255.

dynamic A dynamic configuration, as the name implies, means that it changes. BOOTP and DHCP offer time-based leases for the configurations they assign. Their changes depend on the time-based lease, and how often the printer itself is offline and online again. A dynamic configuration can include BOOTP or DHCP.

Extensible Authentication Protocol over Flexible Authentication via Secure Tunneling (EAP-FAST) Extensible Authentication Protocol-Flexible Authentication via Secure Tunneling (EAP-FAST) is a publicly accessible IEEE 802.1X EAP type developed by Cisco Systems. It is available as an IETF informational draft. Extensible Authentication Protocol-Flexible Authentication via Secure Tunneling (EAP-FAST) is a publicly accessible IEEE 802.1X EAP type developed by Cisco Systems. It is available as an IETF informational draft. Cisco developed EAP-FAST to support customers who cannot enforce a strong password policy and wish to deploy an 802.1X EAP type that does not require digital certificates, supports a variety of user and password database types, supports password expiration and change, and is flexible, easy to deploy, and easy to manage. For example, a customer using Cisco LEAP who cannot enforce a strong password policy and does not want to use certificates can migrate to EAP-FAST for protection from dictionary attacks.

Extensible Authentication Protocol over Transport Layer Security (EAP-TLS) Second generation Wi-Fi security. Current Wi-Fi security standards (802.1x) define the use of the TLS protocol encapsulated within the Extensible Authentication Protocol (EAP) as one of the strongest security mechanisms for Wi-Fi. Using EAP-TLS provides well-regarded, standards-based security between an access point and a Wi-Fi client. This is a Microsoft standard.

- A form of 802.1X (EAP) authentication
- Uses client and server certificates for mutual authentication (PKI)
- TLS 1.0 (Transport Layer Security) is based on Secure Socket Layer (SSL) 3.0

Extensible Authentication Protocol over Tunneled Transport Layer Security (EAP-TTLS) EAP-TTLS is an extension of EAP-TLS which provides for certificate-based, mutual authentication of the client and network. Unlike EAP-TLS, however, EAP-TTLS requires only server-side certificates, eliminating the need to configure certificates for each WLAN client. In addition, it supports legacy password protocols, so you can deploy it against your existing authentication system (such as tokens or Active Directories.) It securely tunnels client authentication within TLS records, ensuring that the user remains anonymous to eavesdroppers on the wireless link and the entire network to the RADIUS server.

Ethernet A widely used local area network system based on the IEEE 802.3 standard.

firmware Software routines that are stored in ROM (Read Only Memory). This is typically part of a device, such as a printer or any print server.

FTP File Transfer Protocol, a TCP/IP-related protocol for transferring files between devices on a network.

Flash memory A type of memory that allows read-and-write operations, but permanently stores data when the power is turned off. Useful for storing firmware because it can be easily updated by downloading new code.

gateway A device that converts one higher-level network protocol to a different higher level protocol.

gleaning A temporary, local configuration option. Gleaning lets you add the address of the device you want to configure to your local workstation's ARP table. This configuration is not permanent and is valid only from the workstation from which you entered the ARP information. After the information is entered into the workstation's ARP table, the user follows up with a Telnet session to enter the information permanently. Note: When using ZebraNet Bridge, a wired PS with an address of 0.0.0.0 can only be discovered through a local broadcast.

IP Internet Protocol, one of the main protocols of the TCP/IP protocol suite.

IP address A network address used by the TCP/IP protocol.

IPP Internet Printing Protocol. Allows you to associate a printer with a URL address that is used for printing over the Internet.

JetAdmin A Hewlett-Packard printer management program available for NetWare and TCP/IP.

Kerberos Network authentication protocol that uses the concept of a time-limited "ticket" for access to network resources. Kerberos uses key distribution and client/server authentication.

Lightweight Extensible Authentication Protocol

(LEAP or Lightweight EAP) A non-standard Wireless Security protocol from Cisco. LEAP uses mutual authentication, meaning that both the user and the access point must be authenticated before access to the LAN is allowed. Mutual authentication can help protect wireless networks from rogue access points, man-in-the-middle attacks, sniffing attacks, and active attacks. Based on 802.1X EAP protocol.

liquid crystal display (LCD) The LCD is a back-lit display that provides the user with either operating status during normal operation or option menus when configuring the printer to a specific application.

logical Refers to conceptual rather than physical. For example, a computer might have a single physical connection to the network (an Ethernet adapter card), but could have logical connections to several other devices on the network.

LPD LPD stand for Line Printer Daemon; it is the part that receives and processes the request. A "daemon" is a server or agent.

MAC Address Media Access Control. Ethernet address that corresponds to the assigned IP address.

name server A workstation on a TCP/IP network that provides a list of all workstations on the network.

node A device connected to a network, such as a computer or print server.

parallel port A port on a device that sends information in groups of bits over multiple wires, one wire for each bit in a group.

ping A TCP/IP command that determines whether a device is accessible on the network.

POP3 Post Office Protocol, the protocol used to retrieve email from the server.

port A physical connector, such as the parallel port, or a logical connection to a device.

post-string A string that is sent at the end of every job going to the logical printer. Maximum 64 characters long.

pre-string A string that is sent at the beginning of each job that goes to the logical printer. Max 64 characters long.

print server A device in a network that changes a network protocol into a printer protocol.

protocol A method of sending and receiving data between two or more workstations on a network, and ensuring that the data is received without errors.

Protected Extensible Authentication Protocol (PEAP) A draft standard for a common approach to wireless-network user authentication.

- A form of 802.1X authentication
- Currently an IETF draft (still subject to change)
- Performs mutual client/server authentication using transport layer security (TLS), but only requires a server certificate
- With no client certificate, configuration is easier than EAP-TLS

RARP Reverse Arp, a standard TCP/IP method of determining a device's IP address based on its Ethernet address.

raw TCP port A type of TCP port in which data is passed unmodified to the receiving node.

RJ45 A type of modular jack connector similar to a telephone connector with up to eight wires. Used for 10BASE-T and 100BASE-T Ethernet connections and for serial port connections.

serial port On a printer or print server, a port that transfers data one bit at a time. Serial ports usually have either a 25-pin, 9-pin "D," or RJ-45 connector setting mode (parallel port).

A mode that the print server is set to for the highest level of parallel port communications.

server A device on a local area network that provides services to client computers on the network.

SMTP Simple Mail Transfer Protocol, a protocol used to send email messages over the Internet.

SNMP Simple Network Management Protocol, a protocol for monitoring and controlling devices on a network.

spooling In printing applications, spooling is the transfer of data to a temporary storage area on disk (the print queue) prior to printing. Spooling allows many jobs to be queued to a single printer.

static Refers to a static IP address. All information is provided by the network administrator.

subnet mask A TCP/IP method of dividing a network into several smaller subnetworks.

TCP/IP Transmission Control Protocol/Internet Protocol, the de facto standard for Internet communications that is widely used on local area networks.

TCP Port A method of accessing a TCP/IP service, where a device with a single IP address can have multiple TCP ports.

Telnet A TCP/IP protocol that allows two devices to communicate over a LAN.

trap An unsolicited message sent by an SNMP agent to an SNMP management station. It notifies the management station of some unusual event.

UNIX A general-purpose computer operating system used on many different kinds of computers.

Wi-Fi Protected Access (WPA) WPA is a security protocol for wireless local area networks (WLANs) that includes encryption and user authentication.

Wireless Encryption Protocol (WEP) WEP is a security protocol for wireless local area networks (WLANs) that secures data transmissions using 64-bit or 128-bit encryption.

ZebraNet 10/100 Print Server An Ethernet connectivity solution.

ZebraLink Allows you to connect and control your bar code printers anywhere and anytime.

ZPL II Zebra Programming Language II is a powerful label-definition and printer-control language.



Notes • _____

Index

000.000.000.000
troubleshooting 142
10/100 print server settings
access 110
192.168.254.254
troubleshooting 142

A

access
10/100 print server settings 110
access point
troubleshooting problems 140
active device selection 56
active print server
determine 55
IP address 55
network configuration label 55
selecting primary network device 56
adaptor for compact flash card 37
address administration protocols
support 16
advanced setup
WebView 97
alerts
set using WebView 64
set using ZebraNet Bridge 63
setting and monitoring 62
ZebraLink 62

assign an IP address 58
from printer control panel (LCD) 59
from ZebraNet Bridge 58
using gleaning 61
using static route 60
via telnet 60
with DHCP 58
authentication
troubleshooting 141

B

browser
configuration settings 67
browser support
requirements 16
BSD-Style print queue
configuration 80

C

calibration
WebView 96
compact flash card
install 37

- configuration label
 - default gateway 43, 46
 - fields to know for external wired print server 43
 - fields to know for internal wired print server 46
 - hardware address 43
 - IP address 43, 46
 - MAC address 43, 46
 - serial number 43
 - subnet mask 43, 46
 - to print an internal wired print server 44
 - to print external wired print server 42
- configuration methods
 - wireless securities 49
- configuration page
 - print server status 118
- configuration problems
 - troubleshooting 136
- configuration settings
 - browser 67
 - check using WebView 67
 - check using ZebraNet Bridge 66
- configure wireless print server
 - through Network Setup Wizard 49
 - through Set/Get/Do (SGD) command 49
 - through ZPL command 49
- contacts 10
- control panel 123
 - menu options 124
 - view wireless status 50
- create new item
 - directory listing 104
- customer service 10

D

- default
 - password 41
 - user ID 41
- default gateway
 - configuration label 43, 46
- default print servers to factory settings
 - using WebView 73
 - using ZebraNet Bridge 74
- default to factory settings
 - print servers 73

- default wired print server to factory settings
 - 105SL printers 74
 - external wired device 74
 - HC100 printers 76
 - PAX4 print engines 74
 - S4M printers 74
 - Xi4 printers 76
 - ZM400 and ZM600 printers 75
 - ZT210, ZT220 printers printers 77
 - ZT230 printers printers 77
- default wireless print server to factory settings
 - HC100 printers 76
 - S4M printers 75
 - Xi4 printers 76
 - ZM400 and ZM600 printers 75
 - ZT210, ZT220 printers 77
 - ZT230 printers 77
- device type 105
- directory listing
 - to create new item 104
 - to view 103
 - WebView 103
- discovery problems
 - troubleshooting 136

E

- enable
 - protocols 70
- enabled protocols
 - print server configuration menu 113
- encryption
 - troubleshooting 141
- external ZebraNet 10/100 Print Server
 - illustration 33
 - install 34
 - installation instructions 32
 - specifications 28

F

- FAQ's 143
- File Transfer Protocol 85
- firmware
 - connection problems after upgrade 139
 - requirements for wired print servers 25
 - requirements for wireless print servers 27
 - upgrade 32
- flash memory 105
- FTP 85

G

- general setup
 - WebView 93
- gleaning
 - assign an IP address 61

H

- hardware address
 - configuration label 43
- HP JetAdmin
 - troubleshooting 138
- HP Web JetAdmin
 - troubleshooting 138

I

- illustration
 - external ZebraNet 10/100 Print Server 33
- install
 - external ZebraNet 10/100 Print Server 34
 - Internal 10/100 Internal Print Server 35
 - wireless print servers 35
 - wireless radio card 35
- install wireless radio card
 - compact flash and adaptor 37
- installation instructions
 - external ZebraNet 10/100 Print Server 32
- Internal 10/100 Internal Print Server
 - install 35
- internal ZebraNet 10/100 Print Server
 - specifications 29
- Internet printing protocol 84
- IP address
 - 192.168.254.254 showing 142
 - all zeroes (000.000.000.000) 142
 - assign using control panel 59
 - assign using ZebraNet Bridge 58
 - assign via telnet session 60
 - configuration label 43, 46
 - for wired and wireless print servers 55
 - troubleshooting issues 142
- IPP
 - print protocol 84
- IPP support 84

K

- Kerberos
 - wireless cards supported 18

L

- label widths
 - requirements to print a configuration label for an internal wired print server 44
 - requirements to print a configuration label for external wired print server 42
- LCD
 - menu options 124
 - network parameters (wired) 124
 - network parameters (wireless) 126
- liability 2
- link status indicator 50

M

- MAC address
 - configuration label 43, 46
- media
 - ordering 10
- media setup
 - WebView 96
- memory locations 105
- memory requirements 24
- menu options
 - control panel 124
 - LCD 124
- multiple print servers
 - active device selection 56

N

- network communications setup
 - primary/secondary settings 99
 - SMTP settings 100
 - SNMP settings 99
 - TCP/IP settings for X60.15.x and ZSPx 100
 - TCP/IP settings for Xi4 Series, ZM Series, RZ Series 101
 - WebView 94
 - wireless encryption setup settings 102
 - wireless setup settings 102
- network configuration screens
 - WebView 98
- network parameters (wired)
 - LCD 124
- network parameters (wireless)
 - LCD 126
- network status/activity indicator
 - troubleshooting the external 10/100 print server 130
 - troubleshooting the internal 10/100 print server 133
- NO CARD INSERTED message 138

- no printer home page
 - troubleshooting 142
- noise level indicator 51
- NOT ASSOCIATED message 138
- NOT AUTHENTICATED message 138

O

- onboard flash 105
- ordering ribbon and media 10
- output port configuration
 - print server configuration menu 117
- overview 16

P

- password
 - default 41
- ping the printer
 - troubleshooting 136
- poor signal strength 138
- POP3 email printing
 - print server configuration menu 117
- prerequisites
 - System V queue 81
- primary network device
 - preference for active print server 56
- primary/secondary settings
 - WebView 99
- print
 - configuration label for an internal wired print server 44
 - configuration label for external wired print server 42
- print a configuration label for an internal wired print server
 - minimum label widths 44
- print a configuration label for external wired print server
 - minimum label widths 42
- print listing on label
 - WebView 94
- print problems
 - troubleshooting 136
- print protocol 84
 - FTP 85
- print queue configuration
 - Berkeley Software Distribution (BSD)-Style 80
- print server
 - reset 120
 - restore 121
 - status and configuration 110
 - to view port status 119

- print server configuration menu
 - enabled protocols 113
 - output port configuration 117
 - POP3 email printing 117
 - SMTP email alert configuration 116
 - SNMP settings 115
 - TCP/IP configuration 114
 - TCP/IP logical printing ports 115
 - web admin settings 116
- print server configuration settings
 - to check 66
- print server features
 - WebView 110
- print server status
 - to open configuration page 118
 - WebView 118
- print servers
 - default to factory settings 73
- printer configuration
 - to view settings 90
 - WebView 90
- printer controls
 - view 108
 - WebView 108
- printer memory 105
- protocols
 - enable 70
 - enabled using WebView 70
 - print server configuration menu 113

Q

- queue configuration
 - BSD-Style 80
 - System V 81

R

- RADIO WARNING POOR SIGNAL message 138
- related documents 13
- requirements
 - browser support 16
 - wired print servers 22
 - wireless print servers 23
- requirements for wired print servers
 - firmware 25
- requirements for wireless print servers
 - firmware 27
- reset
 - print server 120
- reset external wired print server to factory defaults
 - troubleshooting 130

reset internal wired print server to factory defaults
troubleshooting 133

reset wireless print server to factory defaults
troubleshooting 135

restore
print server 121

RFID setup
WebView 95

ribbon
ordering 10

S

sales 10

security type
wireless radio cards 18

serial communications setup
WebView 93

serial number
configuration label 43

set and monitor alerts
using WebView 64
using ZebraNet Bridge 63

signal strength and quality
indicators 51

simultaneous print servers
active device selection 56

SMTP settings
print server configuration menu 116
WebView 100

SNMP settings
print server configuration menu 115
WebView 99

specifications
external ZebraNet 10/100 Print Server 28
internal ZebraNet 10/100 Print Server 29
wireless print server 30

static route
assign an IP address 60

status and configuration
print server 110

subnet mask
configuration label 43, 46

support 16
address administration protocols 16

supported services
wired print servers 16

supported wireless radio cards 17

System V queue
configuration 81
prerequisites 81
UNIX configuration 81

T

TCP/IP configuration
print server configuration menu 114

TCP/IP logical printing ports
print server configuration menu 115

TCP/IP settings for X60.15.x and ZSPx
WebView 100

TCP/IP settings for Xi4 Series, ZM Series, RZ Series
WebView 101

technical support 10

telnet
troubleshooting 137

troubleshooting
000.000.000.000 as IP address 142
configuration problems 136
connection problems after firmware upgrade 139
discovery problems 136
encryption and authentication issues 141
general wireless issues 139
HP Web JetAdmin 138

inconsistent wireless connection 140
IP address 142

IP issues 142

Kerberos 141

network status/activity indicator for the external
10/100 print server 130

network status/activity indicator for the internal 10/
100 print server 133

NO CARD INSERTED message 138

no home page 142

NOT ASSOCIATED message 138

NOT AUTHENTICATED message 138

not connecting to wireless network 139

ping the printer 136

poor signal strength 138

print a configuration label using ZPL command
137

printer won't connect to WLAN 141

RADIO WARNING POOR SIGNAL message
138

reset external wired print server to factory defaults
130

troubleshooting (cont'd.)
 reset internal wired print server to factory defaults 133
 reset wireless print server to factory defaults 135
 system disabled after encryption set 141
 unable to configure device 138
 unable to print 136
 using telnet 137
 WEP key field not large enough 141
 wireless error messages 138
 wireless print server 135
 wireless radio card not acknowledged 139
 WPA mode 141

U

unable to configure device
 troubleshooting 138
 upgrade
 firmware 32
 user ID
 default 41

V

view
 directory listing 103
 port status of print server 119
 printer configuration 90
 printer controls 108
 view and modify printer settings
 advanced setup 97
 calibration 96
 general setup 93
 media setup 96
 network communications setup 94
 print listings on label 94
 RFID setup 95
 serial communications setup 93
 WebView 91
 ZPL control 97

W

web admin settings
 print server configuration menu 116
 web pages
 problems accessing with wired IP address 142

WebView 88
 advanced setup 97
 calibration 96
 check configuration settings 67
 default print servers to factory settings 73
 directory listing 103
 enabled protocols 70
 general setup 93
 home page 88
 media setup 96
 network communications setup 94
 network configuration screens 98
 primary/secondary settings 99
 print listing on label 94
 print server features 110
 print server status 118
 printer configuration 90
 printer controls 108
 reset print server 120
 restore print server 121
 RFID setup 95
 serial communications setup 93
 setting alerts 64
 SMTP settings 100
 SNMP settings 99
 TCP/IP settings for X60.15.x and ZSPx 100
 TCP/IP settings for Xi4 Series, ZM Series, RZ Series 101
 view and modify printer settings 91
 view printer configuration settings 90
 view printer controls 108
 wireless encryption setup settings 102
 wireless setup settings 102
 ZPL control 97
 wired and wireless print servers
 both installed 55
 wired print server
 check during bootup 56
 printer requirements 22
 wired print servers
 supported services 16
 wireless encryption setup settings
 WebView 102
 wireless error messages
 troubleshooting 138

- wireless issues (general)
 - troubleshooting 139
- wireless link status indicator 50
- wireless print server
 - printer requirements 23
 - specifications 30
 - troubleshooting 135
- wireless print servers
 - install 35
- wireless radio card
 - install 35
 - install compact flash card and adaptor 37
 - printer not acknowledging 139
 - supported cards 17
 - supported security types 18
- wireless setup settings
 - WebView 102

- wireless signal indicators 51
- wireless status
 - view through control panel 50
- wireless status indicator lights (HC100) 52
- wireless status indicator lights (ZT210, ZT220, ZT230) 53

Z

- ZebraLink alerts 62
- ZebraLink WebView 88
- ZebraNet Bridge
 - check configuration settings 66
 - configuration problems 136
 - default print servers to factory settings 74
 - discovery problems 136
- ZPL control
 - WebView 97



Zebra Technologies Corporation

Zebra Technologies Corporation
475 Half Day Road, Suite 500
Lincolnshire, IL 60069 USA
T: +1 847 634 6700
Toll-free +1 866 230 9494
F: +1 847 913 8766

Zebra Technologies Europe Limited

Dukes Meadow
Millboard Road
Bourne End
Buckinghamshire, SL8 5XF, UK
T: +44 (0)1628 556000
F: +44 (0)1628 556001

Zebra Technologies Asia Pacific, LLC

120 Robinson Road
#06-01 Parakou Building
Singapore 068913
T: +65 6858 0722
F: +65 6885 0838

<http://www.zebra.com>