

- Snap-in-Verriegelung
- 3 – 8-polig
- Schutzart IP67
- Lötanschluss
- Durchmesser 11,5 mm



Bezeichnung	Maßzeichnung	Polzahl	Kabeldurchlass	Schwarz
Kabelstecker		3	3–5 mm	99 9205 00 03
		4		99 9209 00 04
		5		99 9213 00 05
		8		99 9225 00 08



Bezeichnung	Maßzeichnung	Polzahl	Kabeldurchlass	Farben		
				Rot	Blau	Grün
Kabelstecker, rot, blau, grün		3	3–5 mm	99 9205 050 03	99 9205 060 03	99 9205 070 03
		4		99 9209 050 04	99 9209 060 04	99 9209 070 04
		5		99 9213 050 05	99 9213 060 05	99 9213 070 05
		8		99 9225 050 08	99 9225 060 08	99 9225 070 08



Bezeichnung	Maßzeichnung	Polzahl	Kabeldurchlass	Farben		
				Schwarz	Blau	Grün
Kabeldose		3	3–5 mm	99 9206 00 03		
		4		99 9210 00 04		
		5		99 9214 00 05		
		8		99 9226 00 08		



Bezeichnung	Maßzeichnung	Polzahl	Kabeldurchlass	Farben		
				Schwarz	Blau	Grün
Kabeldose, rot, blau, grün		3	3–5 mm	99 9206 050 03	99 9206 060 03	99 9206 070 03
		4		99 9210 050 04	99 9210 060 04	99 9210 070 04
		5		99 9214 050 05	99 9214 060 05	99 9214 070 05
		8		99 9226 050 08	99 9226 060 08	99 9226 070 08



Technische Daten

Polzahl	3	4	5	8
Anschlussquerschnitt	max. 0,25 mm ² (max. AWG 24)			
Mechanische Lebensdauer	> 500 Steckzyklen			
Grenztemperatur	– 25 °C / + 85 °C			
Bemessungsspannung	125 V		63 V	
Verschmutzungsgrad	2			
Bemessungsstrom (40°C)	3 A	2,5 A	2 A	1 A
Kontaktoberfläche	Au (Gold)			
Material Gehäuse	PA			

Bezeichnung	Maßzeichnung	Polzahl	Kabellänge, PUR	Bestell-Nr.
Kabelstecker, umspritzt		3 x 0,25	2 m	79 9237 020 03
		4 x 0,25		79 9241 020 04
		5 x 0,25		79 9245 020 05
		8 x 0,25		79 9257 020 08



Kabeldose, umspritzt		3 x 0,25	79 9238 020 03
		4 x 0,25	79 9242 020 04
		5 x 0,25	79 9246 020 05
		8 x 0,25	79 9258 020 08



Flanschstecker, Lötanschluss	Schwarz		
		3	99 9207 00 03
	4	99 9211 00 04	
	5	99 9215 00 05	
	8	99 9227 00 08	

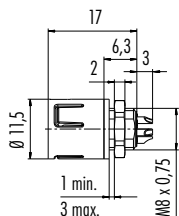

Flanschstecker, Lötanschluss	Rot	Blau	Grün
		3	99 9207 050 03
	4	99 9211 050 04	99 9211 070 04
	5	99 9215 050 05	99 9215 070 05
	8	99 9227 050 08	99 9227 070 08



Flanschstecker, Tauchlötanschluss	Schwarz	
		3
	4	99 9211 090 04
	5	99 9215 090 05
	8	99 9227 090 08

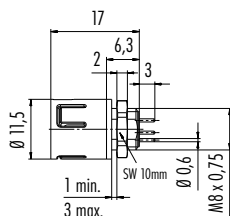

Flanschdose, Lötanschluss	3	99 9208 00 03
	4	99 9212 00 04
	5	99 9216 00 05
	8	99 9228 00 08

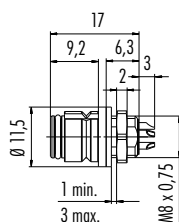

Bezeichnung	Maßzeichnung	Polzahl	Rot	Blau	Grün
Flanschdose, Lötanschluss		3	99 9208 050 03	99 9208 060 03	99 9208 070 03
		4	99 9212 050 04	99 9212 060 04	99 9212 070 04
		5	99 9216 050 05	99 9216 060 05	99 9216 070 05
		8	99 9228 050 08	99 9228 060 08	99 9228 070 08



Schwarz

Flanschdose, Tauchlötanschluss		3	99 9208 090 03
		4	99 9212 090 04
		5	99 9216 090 05
		8	99 9228 090 08



Bestell-Nr.

Adapter für Flanschsteckverbinder	08 2636 000 001
-----------------------------------	-----------------

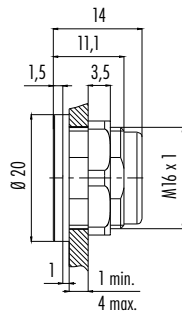

Adapter für Flanschsteckverbinder, von vorn verschraubbar	08 2629 000 001
---	-----------------

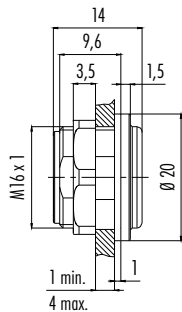

Einzelteildarstellung

Kabelsteckverbinder

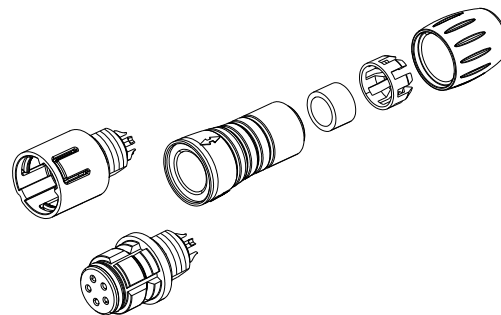

- Steckereinsatz
- Buchseinsatz
- Kupplungshülse
- Dichtring
- Klemmkorb
- Druckschraube

Flanschsteckverbinder

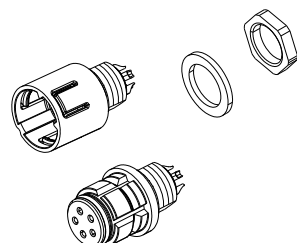

- Steckereinsatz
- Buchseinsatz
- Flachdichtung
- Sechskantmutter

Einzelteildarstellung

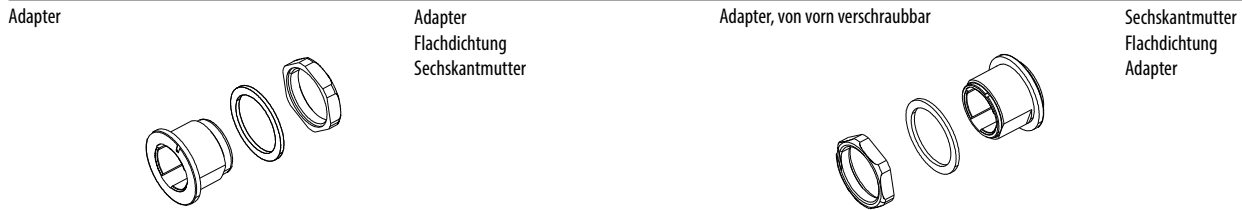

Polbilder Stifteinsatz (Steckseite)



Polbilder Buchseneinsatz (Steckseite)

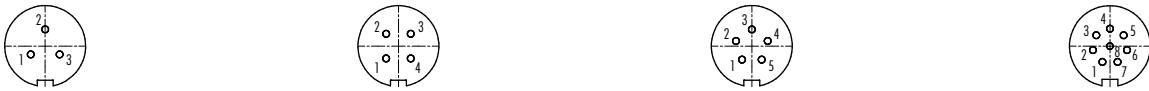

Montageausschnitt

Flanschsteckverbinder

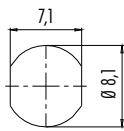

Adapter

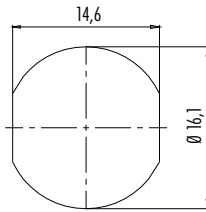

Litzenfarbe, Kabelsteckverbinder umspritzt

- 1 weiß
- 2 braun
- 3 grün
- 4 gelb
- 5 grau
- 6 rosa
- 7 blau
- 8 rot

Bezeichnung

Maßzeichnung

Bestell-Nr.

Schutzkappe für Kabelstecker

08 2813 000 000

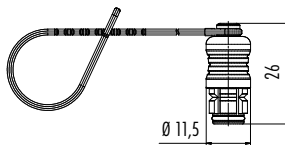

Schutzkappe für Kabeldose

08 2823 000 000

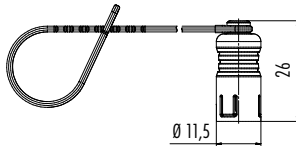

Schutzkappe für Flanschstecker

08 2839 000 000

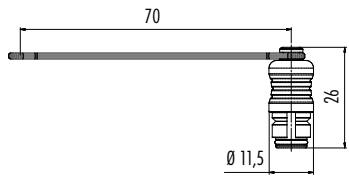

Schutzkappe für Flanschdose

08 2831 000 000

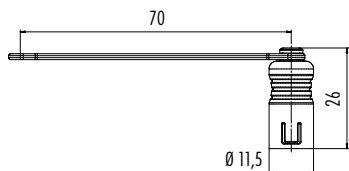



- Snap-in-Verriegelung
- 3 – 8-polig
- Schutzart IP67
- Lötanschluss
- Durchmesser 11,5 mm
- Umspritzte Ausführungen auf Anfrage
- Farbe in grauweiß ähnlich RAL 9002

Bezeichnung	Maßzeichnung	Polzahl	Kabeldurchlass	Grauweiß
Kabelstecker		3	3–5 mm	99 9205 400 03
		4		99 9209 400 04
		5		99 9213 400 05
		8		99 9225 400 08



Bezeichnung	Polzahl	Kabeldurchlass	Farbe		
			Rot	Blau	Grün
Kabelstecker, rot, blau, grün	3	3–5 mm	99 9205 450 03	99 9205 460 03	99 9205 470 03
	4		99 9209 450 04	99 9209 460 04	99 9209 470 04
	5		99 9213 450 05	99 9213 460 05	99 9213 470 05
	8		99 9225 450 08	99 9225 460 08	99 9225 470 08



Bezeichnung	Polzahl	Kabeldurchlass	Farbe		
			Grauweiß		
Kabeldose	3	3–5 mm	99 9206 400 03		
	4		99 9210 400 04		
	5		99 9214 400 05		
	8		99 9226 400 08		



Bezeichnung	Polzahl	Kabeldurchlass	Farbe		
			Rot	Blau	Grün
Kabeldose, rot, blau, grün	3	3–5 mm	99 9206 450 03	99 9206 460 03	99 9206 470 03
	4		99 9210 450 04	99 9210 460 04	99 9210 470 04
	5		99 9214 450 05	99 9214 460 05	99 9214 470 05
	8		99 9226 450 08	99 9226 460 08	99 9226 470 08



Technische Daten

Polzahl	3	4	5	8
Anschlussquerschnitt	max. 0,25 mm ² (max. AWG 24)			
Mechanische Lebensdauer	> 500 Steckzyklen			
Grenztemperatur	–40 °C / + 85 °C			
Bemessungsspannung	125 V		63 V	
Verschmutzungsgrad	2			
Bemessungsstrom (40°C)	3 A	2,5 A	2 A	1 A
Kontaktoberfläche	Au (Gold)			
Material Gehäuse	PA			

Bezeichnung

Maßzeichnung

Polzahl

Lötanschluss

Tauchlötanschluss

Flanschstecker, Lötanschluss/Tauchlötanschluss

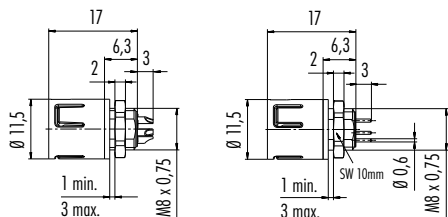

3	99 9207 400 03	99 9207 490 03
4	99 9211 400 04	99 9211 490 04
5	99 9215 400 05	99 9215 490 05
8	99 9227 400 08	99 9227 490 08

Rot Blau Grün

Flanschstecker, Lötanschluss

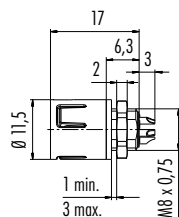

3	99 9207 050 03	99 9207 060 03	99 9207 070 03
4	99 9211 050 04	99 9211 060 04	99 9211 070 04
5	99 9215 050 05	99 9215 060 05	99 9215 070 05
8	99 9227 050 08	99 9227 060 08	99 9227 070 08

Lötanschluss Tauchlötanschluss

Flanschdose, Lötanschluss/Tauchlötanschluss

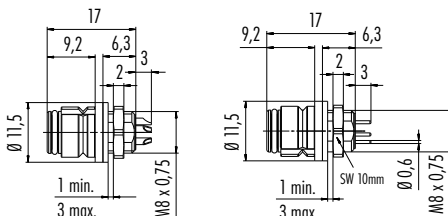

3	99 9208 400 03	99 9208 490 03
4	99 9212 400 04	99 9212 490 04
5	99 9216 400 05	99 9216 490 05
8	99 9228 400 08	99 9228 490 08

Rot Blau Grün

Flanschdose, Lötanschluss

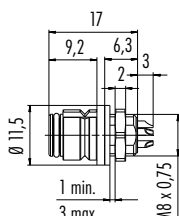

3	99 9208 050 03	99 9208 060 03	99 9208 070 03
4	99 9212 050 04	99 9212 060 04	99 9212 070 04
5	99 9216 050 05	99 9216 060 05	99 9216 070 05
8	99 9228 050 08	99 9228 060 08	99 9228 070 08

Bestell-Nr.

08 2636 400 001

Adapter für Flanschsteckverbinder für versenkten Einbau

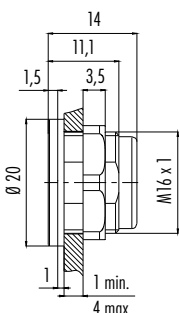

Einzelteildarstellung

Kabelsteckverbinder

Steckereinsatz
 Buchseneinsatz
 Kupplungshülse
 Dichtring
 Klemmkorb
 Druckschraube

Flanschsteckverbinder

Steckereinsatz
 Buchseneinsatz
 Flachdichtung
 Sechskantmutter

Adapter

Adapter
 Flachdichtung
 Sechskantmutter

