

# MVS13x-3,5-H

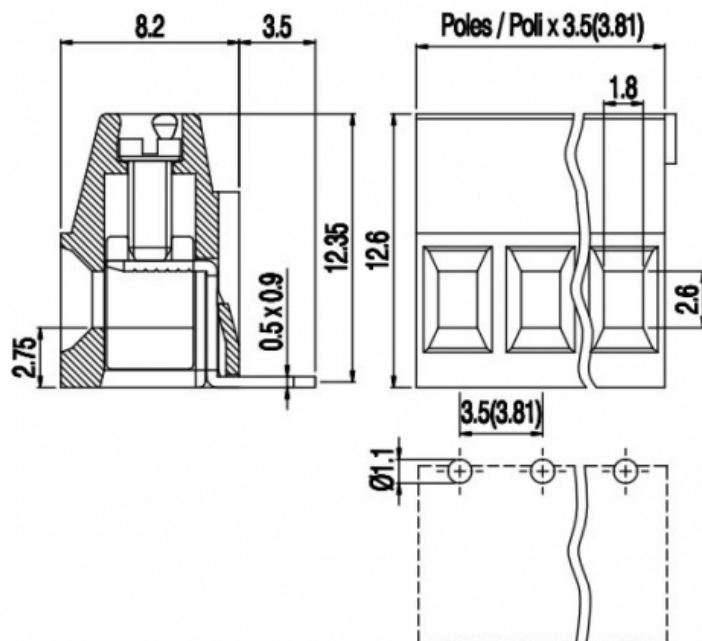

## GENERAL INFORMATIONS

pitch:	3,5 mm
housing height:	12,60 mm
housing depth:	8.2 mm
dimensional class:	slow
wire section:	1.0 mm <sup>2</sup> / 16 AWG
clamp opening size:	1.8 x 2.6 mm
wire stripping:	max 6 mm
operating temperature:	-40°C ÷ +130°C

## ELECTRICAL CHARACTERISTICS

current:	13,5A
voltage:	130V
test voltage:	1.25 kVrms/60s

## MECHANICAL CHARACTERISTICS

screw:	M2
max. torque:	0.2 Nm / 1.8 in.lbs

## APPROVALS DATA



EN 60998-1

current: 13.5A

voltage: 130V

wire section: 1.0mm<sup>2</sup>

torque: 0.2Nm

FILE: CA02.04718



-

-

-

-

-

-



UL 1059

12A factory / 10A field

150V

16÷30AWG

1.8Lb-in

E178356

## MATERIALS

housing: PA - UL 94 V0

screw: Galvanized steel

clamp/spring: Tin-plated copper alloy

## AVAILABLE COLOURS



other colours:

upon request

terminal:

Tin-plated copper alloy

poles	P/N	pcs/pack	W [Kg]*	W [Kg]*
2	MVS132-3,5-H	N/A	N/A	N/A
3	MVS133-3,5-H	N/A	N/A	N/A
4	MVS134-3,5-H	N/A	N/A	N/A
5	MVS135-3,5-H	N/A	N/A	N/A
6	MVS136-3,5-H	N/A	N/A	N/A
7	MVS137-3,5-H	N/A	N/A	N/A
8	MVS138-3,5-H	N/A	N/A	N/A
9	MVS139-3,5-H	N/A	N/A	N/A
10	MVS1310-3,5-H	N/A	N/A	N/A
11	MVS1311-3,5-H	N/A	N/A	N/A
12	MVS1312-3,5-H	N/A	N/A	N/A
..	MVS13...-3,5-H	N/A	N/A	N/A